

Medical Mattress Catalog

Marathon Mattress™ Series



Contents

-  Stretcher & Gurney 6-22
-  Operating Tables 23-26
-  X-Ray, Angio & Cath Lab. 27-28
-  Overlay/Comfort Pads . . . 29-32
-  General Patient/ICU 33-37
-  Bariatric 38-40
-  V36 Deck Bed. 41
-  Side Rail Pads 42-43
-  Labor and Delivery 44-48
-  Pediatric 49-52

All of our Products are Made in the U.S.A.

At North America Mattress Corp., we specialize in manufacturing healthcare mattresses. Our extensive range includes hospital mattresses, stretcher pads, overlays, and disaster relief mattresses. In addition to our healthcare collection, we offer replacement mattresses for semi-truck, conversion vans, RV's and other outdoor sleep systems. Our product line also extends into a complete line of dorm mattress, camping & sleep pads, as well as residential mattresses.

Rest assured, each mattress from NAMC is handmade in our Clackamas, Oregon facility with attention to detail and high-quality standards. Our American-made mattresses are created for comfort, support, durability, quality and value.

INVEST IN A QUALITY MATTRESS

Industry Leading Comfort

Our pressure mapped custom foam layering ensures a level of comfort to provide a restful night's sleep.

Durability You Can Trust

Advanced stability layers provide long lasting comfort without sagging, ensuring a consistent, hard-working performance every time it's used.

Easily Cleaned Removable Covers

Our covers that are expertly made to provide a safe, comfortable, and durable solution for the healthcare industry.

Quality Assurance

Proudly American-made and veteran owned, we stand behind our products with a 12-month warranty.



MANUFACTURING

We source and manufacture 100% of our materials right here in the U.S.A. All mattresses are made with the highest quality materials and go through rigorous quality assurance before leaving the warehouse. Every mattress is backed by our 12 Month Warranty.

UNIQUE DESIGNS

Made for comfort!

Our uniquely designed mattresses ensure a restful night's sleep by letting our customers choose the right mattress to fit their personal needs. All mattresses go through quality assurance before leaving the factory; every mattress meets strict U.S. fire codes, are hypo-allergenic, anti-bacterial, and easily cleaned!



North America Mattress Corp. has been Awarded the Gold HIRE Vets Medallion Program Demonstration Award by the United States Department of Labor every year since program began in 2018.

The HIRE Vets Medallion Program recognizes employers for their efforts to recruit, employ, and retain our Nation's veterans. The Honoring Investments in Recruiting and Employing American Military Veterans (HIRE Vets) Act of 2017 was signed into law in May 2017. The Department of Labor's Veterans' Employment and Training Service (VETS) administers the HIRE Vets Medallion Program.

Replacing Your Mattresses

By staying proactive in maintaining your hospital mattresses, you are safeguarding the well-being of your patients and promoting a hygienic environment within your healthcare facility. Follow these tips to ensure the integrity of your mattress.



Develop an Inspection Plan

Create an inspection plan for all hospital bed mattresses and mattress covers in your facility.

Follow the manufacturer's guidelines for expected lifespan and any additional recommendations. Replace when necessary.

Contact the mattress cover manufacturer for any additional questions not covered here.



Inspect

Regularly check each hospital mattress cover for any visible signs of damage or wear such as cuts, tears, cracks, pinholes, snags, or stains.

Routinely remove the hospital bed mattress cover and check inside surface. Once the mattress cover is removed, inspect the mattress for wet spots, staining, or signs of damage or wear. Check all sides and the bottom of the mattress.

Be aware that it may be difficult to identify damaged or soiled mattresses without removing the mattress cover first. Mattress covers tend to be dark in color, making it hard to see what lies underneath.



Remove and Replace

Remove any damaged, worn, or visibly stained hospital bed mattress according to the healthcare facility's procedures and manufacturer's instructions.

Immediately replace any mattress cover with visible signs of stains, damage or wear to reduce the risk of infection to patients.



Maintain

Clean and disinfect undamaged mattress covers according to the manufacturer's guidelines.

DO NOT stick needles into a hospital bed mattress through the mattress cover.



Cleaning and Disinfecting

NAMC uses medical-grade fabrics that are designed to be safe, comfortable, and long lasting in a healthcare setting. Our fabrics are stain resistant from most medications, oils, grease and contaminants. The antimicrobial fabric protection system lasts for the lifespan of the fabric. To maximize the life of your mattress cover, NAMC recommends regular cleaning as follows:

GENERAL CLEANING:

- Soils or Stains: Use neutral soap suds and lukewarm water. Do not use harsh cleansers, solvents or detergents.
- Hard-to-Clean Spots: Use standard household/vinyl cleansers, a soft bristle brush and gentle agitation on troublesome spots or stains. Pre-soak heavy, dried-on soil.

DISINFECTING:

- Phenolic disinfectants, such as “Simple Green d PRO 5”, are the best choice for vinyl products, though properly diluted quaternaries are also acceptable. Phenolic should be avoided on urethane.
- Ammonia disinfectants are recommended for urethane products. Quaternary/Isopropyl disinfectants are recommended for urethanes, but not recommended for vinyl.
- All NAMC fabrics are cleaned with a 1:30 dilution of “Simple Green d PRO 5” There is no harmful effect on the fabric when used in this dilution ratio.

SPECIFIC COMMERCIAL DISINFECTANTS:

- There are many popular disinfectants being used in care facilities. Cavi-Wipes and Virox5 are two of these that have been tested by Herculite and found to be acceptable for use with NAMC healthcare fabrics when used according to manufacturer’s recommendations.
- Other specific products can be tested by NAMC when the request is accompanied by an unopened product sample. Contact your Sales Representative to coordinate this. Results are communicated in approximately 4-6 weeks.

LAUNDERING:

- Machine washing or drying vinyl-laminated or rubber-coated NAMC fabrics is not recommended. Laundering may substantially decrease the useful life of the fabric.
- Polyurethane-coated Sure-Chek fabrics: machine-wash with detergent up to 120°. (Some surface wrinkling may occur. This wrinkling has no adverse effect on the fabric properties). Hang or tumble dry thoroughly at 140° before storage. Using Hypochlorite as recommended by the Center for Disease Control, there is no harmful effect on the fabric when used in this dilution ratio.

PRECAUTIONS:

- Disinfectants applied at full concentration or in highly concentrated solutions may damage the fabric and will decrease the useful life of Sure-Chek fabrics.
- Iodophor type disinfectants used on NAMC fabrics may result in staining. If stains from Iodopher (i.e. iodine bearing) type disinfectants are not treated with a diluted (10:1) bleach solution within 20 minutes of application or spillage, staining will occur.
- Storage of fabrics that have not been dried thoroughly before folding and storing can promote the growth of mildew.

LIST OF CHEMICALS TESTED BY NAMC:

Believed to be safe to use on NAMC brand healthcare fabrics when used according to manufacturer’s directions.

- Simple Green d PRO 5 (used by NAMC)
- Virox 5 Cleaner
- Oxivir® TB Disinfectant Cleaner
- CaviWipes Disinfecting Towels
- ProCure V - Active Ingredient: Chlorine Dioxide
- PDI Sani-Cloth HB Germicidal Disposable Wipe
- Clorox Healthcare Bleach Germicidal Wipes
- Super Sani-Cloth
- Pro-Q256 Cleaners

Stretchers

Marathon Mattress™ Series



Fabrics

Bed and stretcher mattresses come in a variety of materials. Our Ultra Comfort stretchers feature Nymed 6™ healthcare grade nylon top covers and a non-slip, gripable, four way stretch, bottom covers. Standard stretcher models feature Vynmed™ healthcare vinyl top and bottom covers.

| | Nymed™ Nylon | Vynmed™ Vinyl |
|--|-----------------|------------------|
| Breathable | ● | ● |
| Keeps Patients Cool and Dry | ● | ● |
| Anti-bacterial, Anti-fungal, Hypo allergenic | ● | ● |
| Non-Conductive, Antistatic | ● | ● |
| Stain Resistant | ● | ● |
| Fluid Resistant | ● | ● |
| Non-allergenic, Phthalate Free, Latex Free, Non-irritating | ● | ● |
| Odor Resistant | ● | ● |
| Easy to Clean | ● | ● |
| Our overall most durable fabric | ● | ● |



Color Identifier

Color Identifier (tagging) at the mattress foot is now included as a standard feature on all NAMC Stretcher Mattresses. Distinguish old mattresses from new or use for departmental identification. Standard yellow identifier (tagging) included, optional colors (red or blue) available upon request.

Choosing the Right Mattress

NAMC Stretcher & Gurney Mattresses feature multi-layered, CertiPUR-US foam. The removable covers are fluid proof, anti-bacterial, anti-fungal, stain resistant and come with a protective fluid flap over the heavy-duty zipper located under the mattress (the zipper is located at the foot) to ensure no fluid contamination. All mattresses include a standard yellow color identifier at foot.

| Features | Standard | Ultra-Comfort | Bariatric |
|---|----------|---------------|-----------|
| Cool Gel Infused Memory Foam | | ● | |
| Multi-layer High-resiliency Foam | ● | ● | ● |
| Water Resistant Cover | ● | ● | ● |
| Secondary Fluid Barrier (protects foam if outer layer is compromised) | ● | ● | ● |
| Removable Cover | ● | ● | ● |
| Fluid Protection Flap Over Zipper | ● | ● | ● |
| Color Identifier (tagging) | ● | ● | ● |
| Easy to Clean | ● | ● | ● |
| Shear Liner (optional feature) | ● | ● | ● |
| Latex Free | ● | ● | ● |
| FirmEdge™ Passive Restraint System | | ● | ● |
| Weight Capacity | 300lbs | 300lbs | 500lbs |
| Mattress Weight | 20lbs | 25lbs | 40lbs |
| Warranty | 12/mo. | 12/mo. | 12/mo. |
| Made in the USA | ● | ● | ● |
| CertiPUR-US Certified Foam | ● | ● | ● |

Standard Mattress Features

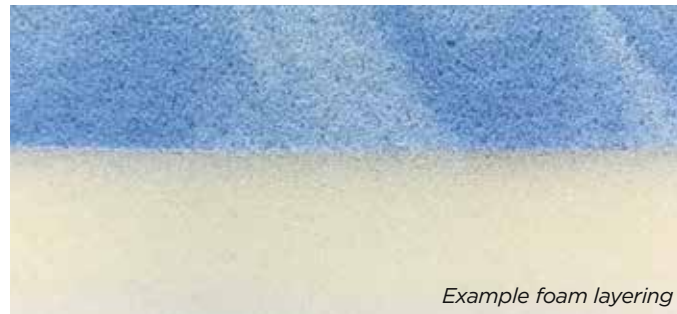

Example foam layering



Heavy-duty Zipper

On bottom allows for internal mattress inspection & easy replacement.



Fluid Protection Flap Over Zipper

Designed to direct fluids over and away from the zipper area.



Flame Retardant

Meets California Technical Bulletin 121 and CFR 1632.



Secondary Fluid Barrier

Assembled between foam and cover providing unique two-way protection.

- Protects foam if outer cover is compromised
- Protects cover by preventing foam's plasticizers from embrittling the fabric, extending cover life



CertiPUR-US Certified Foam

- Made without ozone depleters, PBDEs, TDCPP or TCEP ("Tris") flame retardants
- Made without mercury, lead and other heavy metals
- Made without formaldehyde
- Made without phthalates regulated by the Consumer Product Safety Commission
- Low VOC (Volatile Organic Compound) emissions for indoor air quality (less than 0.5 parts per million)



Color Identifier (tagging)

Standard yellow identifier (tagging) included, optional colors (red or blue) upon request.



12 Month Standard Warranty

Standard warranty covers material and workmanship. Extended warranty available.



Made in the USA - Veteran Owned

Quality workmanship using locally sourced materials.

Unique Features



Removable Nymed™ Cover

Flame resistant, water resistant, anti-bacterial, anti-fungal, antistatic, non-allergenic, non-irritating, and is latex free.



Removable Vynmed™ Cover

Durable, breathable Vynmed™ healthcare vinyl. Soft-supple feel offers exceptional comfort. Anti-bacterial, anti-fungal, water resistant, stain resistant, antistatic, non-allergenic, non-irritating and is latex free.



FirmEdge™ Passive Restraint System

Provides support on both sides of the mattress during entry and egress. (On ultra comfort model only)



Patient Weight Limit

Depending on the model selected our mattress provides support for patients up to 300lbs. for the standard and ultra comfort.



Bariatric model supports up to 500lbs. and 1000lbs.



Cool Gel Memory Foam

Plush and luxurious, evenly distributes body weight, infused liquid gel for a cooler sleep experience, wicks heat away from body. (On ultra comfort model only)



Multi-Layer Performance Foam

Soft surface/firm base for comfort and support.

Current, Obsolete & Custom

We specialize in crafting mattresses for both current and obsolete models, offering a direct-from-the-manufacturer solution. With our expertise, you can trust that your mattresses are tailored to meet the specific needs of your facility, providing quality and comfort directly from the source.



Choose with confidence as we offer replacement mattresses compatible with a wide range of brands, including but not limited to:

Hill-Rom®
Hausted®
Midmark®
Toshiba®

Skytron®
Borg-Warner®
Simmons®
Stryker®

Wilro®
Amsco®
Amedco®
Invacare®

The brands listed on this document are owned by those brands, they are listed only for the convenience of our customers.

B2B Solutions

Discover unparalleled quality and reliability with our B2B offerings - hospital mattresses direct from the manufacturer. As industry leaders since 1996, NAMC has been expertly producing customized solutions that meet the unique needs of healthcare facilities.

Partner with us to ensure your clients receive mattresses crafted with precision, designed for comfort, and backed by our commitment to excellence. Streamline your supply chain and elevate patient care with our direct-from-the-source hospital mattresses. Request a quote today to experience the difference of working directly with the experts in healthcare sleep solutions.

Standard Stretcher

Multi-layered, Medical Grade,
High Resiliency, Urethane Foam



Our economical, standard stretcher replacement mattresses meet or exceed OEM specifications.

4" thick CertiPUR-US foam provides comfortable support for individuals up to 300lbs.

- Soft conforming layer
- Supportive firm foam base layer

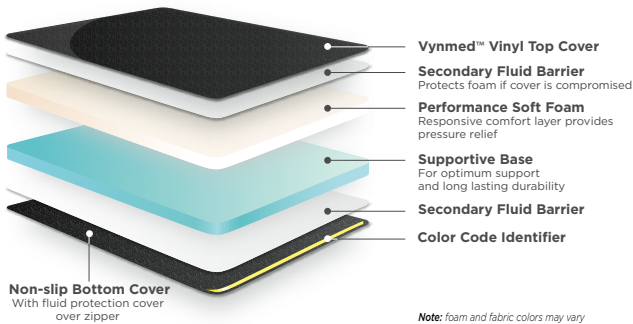

Note: foam and fabric colors may vary

Color Identifier located at foot end.

Distinguish old mattresses from new or use for departmental identification. Standard yellow identifier (tagging) included, optional colors available upon request.

Vynmed™ Healthcare Vinyl Cover

- Durable, soft-supple feel offers exceptional comfort
- Anti-bacterial, anti-fungal, water resistant, stain resistant
- Non-allergenic, non-irritating, conductive
- Phthalate free, latex free and odor resistant

Secondary Fluid Barrier

- Assembled between foam and cover provides a unique protection; if the outer layer is compromised, foam is protected

Removable Cover











- Heavy duty zipper on bottom allows for internal mattress inspection and easy replacement
- Includes fluid protection flap over zipper which directs fluids over and away from the zipper area

NEW! Non Slip Bottom Material



Conforming Layer

Supportive Base

-  Multi-layer Performance Foam
-  Patient Weight Limit 300
-  Removable Vynmed™ Cover
-  Heavy-duty Zipper
-  Fluid Protection Flap Over Zipper
-  Secondary Fluid Barrier
-  Universal Velcro Location For Easy Installation
-  Color Identifier
-  CertiPUR-US Foam
-  12 Month Warranty
-  Made in the USA

Vynmed™ Vinyl Cover

Fluid Flap Over Heavy-Duty Zipper

Color Identifier

Ultra-Comfort Stretchers

Stretcher & Gurney Mattresses

Cool Gel Memory Foam, Non Slip Bottom



Nymed 6™ stretchable nylon cover accompanied with our multi-layered, ultra comfort, medical grade, high resiliency, urethane foam.

4" or 5" thick CertiPUR-US foam provides comfortable support for individuals up to 300lbs.

- Cool Gel infused memory foam top layer
- Performance soft foam internal layer
- Supportive firm foam base layer

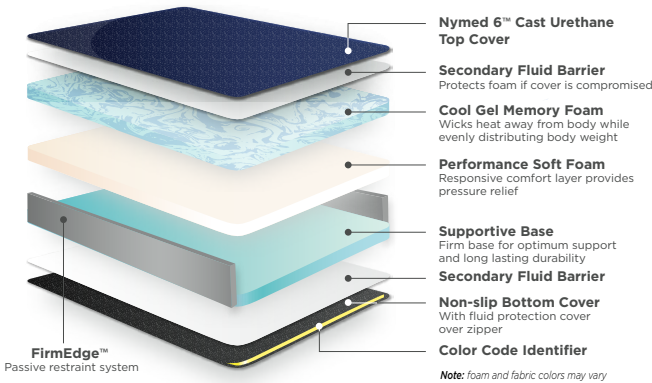

NEW! Non Slip Bottom Material

Color Identifier located at foot end.

Distinguish old mattresses from new or use for departmental identification. Standard yellow identifier (tagging) included, optional colors available upon request.

FirmEdge™ Passive Restraint System

- Provides support on both sides of the mattress during entry and egress

Nymed 6™ Healthcare Grade Cast Urethane Top Cover

- Water resistant
- Anti-bacterial, anti-fungal, non-allergenic
- Non-irritating, latex free

Vynmed™ Non Slip Bottom Material

- Anti-bacterial, anti-fungal, water & stain resistant
- Non-allergenic, non-irritating
- Phthalate free, latex free and odor resistant
- Keeps mattress on stretcher

Secondary Fluid Barrier

- Assembled between foam and cover provides a unique protection; if the outer layer is compromised, foam is protected

Removable Cover

- Heavy duty zipper on bottom allows for internal mattress inspection and easy replacement
- Includes fluid protection flap over zipper which directs fluids over and away from the zipper area

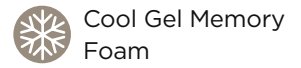
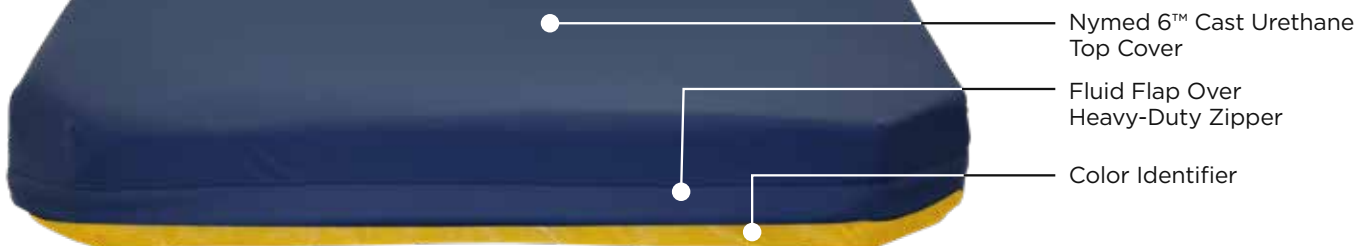
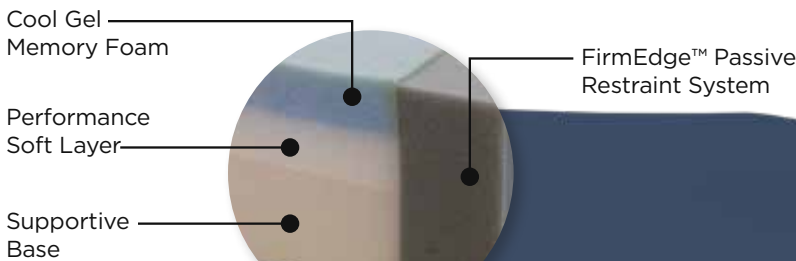

Cool Gel Memory Foam



FirmEdge™ Passive Restraint



Patient Weight Limit 300



Removable Cast Urethane Cover



Heavy-duty Zipper



Fluid Protection Flap Over Zipper



Secondary Fluid Barrier



Non Slip Bottom



Color Identifier



CertiPUR-US Foam











12 Month Warranty



Made in the USA



Stryker Stretchers

| Stryker | Stretcher | Model | Standard 4" | Ultra Comfort 4" | Ultra Comfort 5" |
|---|-----------|-------------|----------------------|----------------------------|----------------------------|
|  (26" Width) | Transport | Stryker 700 | 700-4 | 700-4-UC | 700-5-UC |
|  (24" and 26" Widths) | Transport | Stryker 721 | 721-24-4 721-26-4 | 721-24-4-UC 721-26-4-UC | 721-24-5-UC 721-26-5-UC |
|  (26" and 30" Widths) | Transport | Stryker 737 | 737-26-4 737-30-4 | 737-26-4-UC 737-30-4-UC | 737-26-5-UC 737-30-5-UC |
|  (26" and 30" Widths) | Transport | Stryker 738 | 738-26-4 738-30-4 | 738-26-4-UC 738-30-4-UC | 738-26-5-UC 738-30-5-UC |
|  (24" Width) | Gurney | Stryker 916 | 916-4 | 916-4-UC | 916-5-UC |
|  (26" Width) | Transport | Stryker 919 | 919-4 | 919-4-UC | 919-5-UC |
|  (24" and 26" Widths) | ED II | Stryker 926 | 926-24-4 926-26-4 | 926-24-4-UC 926-26-4-UC | 926-24-5-UC 926-26-5-UC |
|  (26" and 29" Widths) | PACU | Stryker 946 | 946-26-4 946-29-4 | 946-26-4-UC 946-29-4-UC | 946-26-5-UC 946-29-5-UC |
|  (24" Width) | Emergency | Stryker 952 | 952-4 | 952-4-UC | 952-5-UC |







Stryker Stretchers CONT.

| Stryker | Stretcher | Model | Standard 4" | Ultra Comfort 4" | Ultra Comfort 5" |
|---|------------------------|--------------|------------------------|------------------------------|------------------------------|
|  (24" Width) | Emergency | Stryker 960 | 960-4 | 960-4-UC | 960-5-UC |
|  (24" Width) | Emergency | Stryker 966 | 966-4 | 966-4-UC | 966-5-UC |
|  (26" and 30" Widths) | VIP Table | Stryker 974 | 974-26-4 973-30-4 | 974-26-4-UC 974-30-4-UC | 974-26-5-UC 974-30-5-UC |
|  (24" Width) | Advantage | Stryker 1001 | 1001-4 | 1001-4-UC | 1001-5-UC |
|  (26" and 30" Widths) | Trauma | Stryker 1002 | 1002-26-4 1002-30-4 | 1002-26-4-UC 1002-30-4-UC | 1002-26-5-UC 1002-30-5-UC |
|  (26" and 30" Widths) | ER PACU Transport | Stryker 1007 | 1007-26-4 1007-30-4 | 1007-26-4-UC 1007-30-4-UC | 1007-26-5-UC 1007-30-5-UC |
|  (26" Width) | Advantage | Stryker 1009 | 1009-4 | 1009-4-UC | 1009-5-UC |
|  (26" Width) | ER & Transport | Stryker 1010 | 1010-4 | 1010-4-UC | 1010-5-UC |
|  (26" and 30" Widths) | Transport Big Wheel | Stryker 1015 | 1015-26-4 1015-30-4 | 1015-26-4-UC 1015-30-4-UC | 1015-26-5-UC 1015-30-5-UC |

Stryker Stretchers CONT.

| Stryker | Stretcher | Model | Standard 4" | Ultra Comfort 4" | Ultra Comfort 5" |
|---|------------------------|---|------------------------|------------------------------|------------------------------|
|  (26" Width) | Trauma | Stryker 1020 | 1020-4 | 1020-4-UC | 1020-5-UC |
|  (26" and 30" Widths) | Prime Zoom M Series | Stryker 1025 | 1025-26-4 1025-30-4 | 1025-26-4-UC 1025-30-4-UC | 1025-26-5-UC 1025-30-5-UC |
|  (26" Width) | L & D | Stryker 1060 (2 Piece Set) | 1060-4 | 1060-4-UC | 1060-5-UC |
|  (26" Width) | L & D | Stryker 1061 (2 Piece Set) | 1061-4 | 1061-4-UC | 1061-5-UC |
|  (24" Width) | EYE | Stryker 1067 | 1067-4 | 1067-4-UC | 1067-5-UC |
|  (26" Width) | EYE | Stryker 1068 (Body Section) | 1068-4 | 1068-4-UC | 1068-5-UC |
|  | EYE | Stryker 1068 (Head Section - Flat) | 1068-4-H-F | 1068-4-H-F-UC | 1068-5-H-F-UC |
|  | EYE | Stryker 1068 (Head Section - Concave) | 1068-4-H-C | 1068-4-H-C-UC | 1068-5-H-C-UC |





Stryker Stretchers CONT.

| Stryker | Stretcher | Model | Standard 4" | Ultra Comfort 4" | Ultra Comfort 5" |
|--|-------------|--|-------------|------------------|------------------|
|  (26" Width) | EYE | Stryker 1069 (Body Section) | 1069-4 | 1069-4-UC | 1069-5-UC |
|  | EYE | Stryker 1069 (Head Section - Flat) | 1069-4-H-F | 1069-4-H-F-UC | 1069-5-H-F-UC |
|  | EYE | Stryker 1069 (Head Section - Concave) | 1069-4-H-C | 1069-4-H-C-UC | 1069-5-H-C-UC |
|  (26" Width) | Fluoroscopy | Stryker 1080 | 1080-4 | 1080-4-UC | 1080-5-UC |
|  (26" Width) | EYE | Stryker 1089 (Body Section) | 1089-4 | 1089-4-UC | 1089-5-UC |
|  | EYE | Stryker 1089 (Head Section - Flat) | 1089-4-H-F | 1089-4-H-F-UC | 1089-5-H-F-UC |
|  | EYE | Stryker 1089 (Head Section - Concave) | 1089-4-H-C | 1089-4-H-C-UC | 1089-5-H-C-UC |



Stryker Stretchers CONT.

| Stryker | Stretcher | Model | Standard 4" | Ultra Comfort 4" | Ultra Comfort 5" |
|---|---------------------------|--------------|------------------------|------------------------------|------------------------------|
|  (26" and 30" Widths) | 5th Wheel Prime | Stryker 1105 | 1105-26-4 1105-30-4 | 1105-26-4-UC 1105-30-4-UC | 1105-26-5-UC 1105-30-5-UC |
|  (26" and 30" Widths) | Prime Series Big Wheel | Stryker 1115 | 1115-26-4 1115-30-4 | 1115-26-4-UC 1115-30-4-UC | 1115-26-5-UC 1115-30-5-UC |
|  (26" and 30" Widths) | Zoom Prime | Stryker 1125 | 1125-26-4 1125-30-4 | 1125-26-4-UC 1125-30-4-UC | 1125-26-5-UC 1125-30-5-UC |
|  (26" and 29" Widths) | Renaissance | Stryker 1210 | 1210-26-4 1210-29-4 | 1210-26-4-UC 1210-29-4-UC | 1210-26-5-UC 1210-29-5-UC |
|  (26" and 29" Widths) | Renaissance | Stryker 1211 | 1211-26-4 1211-29-4 | 1211-26-4-UC 1211-29-4-UC | 1211-26-5-UC 1211-29-5-UC |
|  (29" Width) | Advantage | Stryker 1501 | 1501-4 | 1501-4-UC | 1501-5-UC |
|  (26" and 29" Widths) | PACU | Stryker 1509 | 1509-26-4 1509-29-4 | 1509-26-4-UC 1509-29-4-UC | 1509-26-5-UC 1509-29-5-UC |
|  (26" Width) | Advantage | Stryker 1510 | 1510-4 | 1510-4-UC | 1510-5-UC |





Stryker Stretchers CONT.

| Stryker | Stretcher | Model | Standard 4" | Ultra Comfort 4" | Ultra Comfort 5" |
|---|---------------|--------------|------------------------|------------------------------|------------------------------|
|  (26" and 30" Widths) | Advantage | Stryker 1550 | 1550-26-4 1550-30-4 | 1550-26-4-UC 1550-30-4-UC | 1550-26-5-UC 1550-30-5-UC |
|  (26" Width) | Advantage | Stryker 1710 | 1710-4 | 1710-4-UC | 1710-5-UC |
|  (26" and 29" Widths) | Advantage | Stryker 1711 | 1711-26-4 1711-29-4 | 1711-26-4-UC 1711-29-4-UC | 1711-26-5-UC 1711-29-5-UC |
|  (24" Width) | Eye Stretcher | Stryker 5051 | 5051-4 | 5051-4-UC | 5051-5-UC |

Pedigo Stretchers

| Pedigo | Stretcher | Model | Standard 4" | Ultra Comfort 4" | Ultra Comfort 5" |
|---|-----------|-----------------------|-------------|------------------|------------------|
|  | Transport | Pedigo 511/540/550 | 5829002 | 5828002-UC | 5829002-UC |
|  | Transport | Pedigo 516/545/555 | 5832002 | 5831002-UC | 5832002-UC |
|  | Transport | Pedigo 530 | 5803002 | 5802002-UC | 5803002-UC |



Midmark Stretchers

| Midmark | Stretcher | Model | Standard 4" | Ultra Comfort 4" | Ultra Comfort 5" |
|---|-----------|-------------|-------------|------------------|------------------|
|  | Transport | Midmark 511 | 511-4 | 511-4-UC | 511-5-UC |
|  | Transport | Midmark 516 | 516-4 | 516-4-UC | 516-5-UC |
|  | Universal | Midmark 540 | 540-4 | 540-4-UC | 540-5-UC |
|  | PACU | Midmark 545 | 545-4 | 545-4-UC | 545-5-UC |
|  | Universal | Midmark 550 | 550-4 | 550-4-UC | 550-5-UC |





Hill-Rom Stretchers

| Hill-Rom | Stretcher | Model | Standard 4" | Ultra Comfort 4" | Ultra Comfort 5" |
|---|-------------------|---------------|------------------------|------------------------------|------------------------------|
|  | GPS | Hill-Rom 880 | 880-4 | 880-4-UC | 880-5-UC |
|  | GPS | Hill-Rom 881 | 881-4 | 881-4-UC | 881-5-UC |
|  | GPS | Hill-Rom 882 | 882-4 | 882-4-UC | 882-5-UC |
|  | GPS | Hill-Rom 883 | 883-4 | 883-4-UC | 883-5-UC |
|  | GPS | Hill-Rom 885 | 885-31-4 | 885-31-4-UC | 885-31-5-UC |
|  | GPS | Hill-Rom 886 | 886-31-4 | 886-31-4-UC | 886-31-5-UC |
|  (26" and 30" Widths) | TranStar | Hill-Rom 8000 | 8000-26-4 8000-30-4 | 8000-26-4-UC 8000-30-4-UC | 8000-26-5-UC 8000-30-5-UC |
|  | DuraStar | Hill-Rom 8005 | 8005-4 | 8005-4-UC | 8005-5-UC |
|  | TranStar Surgical | Hill-Rom 8010 | 8010-4 | 8010-4-UC | 8010-5-UC |
|  | TranStar Electric | Hill-Rom 8020 | 8020-4 | 8020-4-UC | 8020-5-UC |

Hill-Rom Stretchers CONT.

| Hill-Rom | Stretcher | Model | Standard 4" | Ultra Comfort 4" | Ultra Comfort 5" |
|---|-----------------|---------------|-------------|------------------|------------------|
|  | TranStar Fixed | Hill-Rom 8030 | 8030-4 | 8030-4-UC | 8030-5-UC |
|  | TranStar Trauma | Hill-Rom 8040 | 8040-4 | 8040-4-UC | 8040-5-UC |
|  | TranStar OB/Gyn | Hill-Rom 8050 | 8050-4 | 8050-4-UC | 8050-5-UC |







Hausted Stretchers

| Hausted | Stretcher | Model | Standard 4" | Ultra Comfort 4" | Ultra Comfort 5" |
|---|--|----------------|----------------------|----------------------------|----------------------------|
|  (28" and 30" Widths) | Horizon Series Ameriglide & Retracto | Hausted 428 | 428-28-4 428-30-4 | 428-28-4-UC 428-30-4-UC | 428-28-5-UC 428-30-5-UC |
|  | Horizon Youth Series | Hausted 462 | 462-4 | 462-4-UC | 462-5-UC |
|  | Converge II | Hausted 471 | 471-4 | 471-4-UC | 471-5-UC |
|  | Converge II | Hausted 472 | 472-4 | 472-4-UC | 472-5-UC |

Hausted Stretchers CONT.

| Hausted | Stretcher | Model | Standard 4" | Ultra Comfort 4" | Ultra Comfort 5" |
|---|----------------------|--------------|-------------|------------------|------------------|
|  | Surgi-Stretcher | Hausted 575 | 575-4 | 575-4-UC | 575-5-UC |
|  | Transport | Hausted 600 | 600-4 | 600-4-UC | 600-5-UC |
|  | Transport | Hausted 610 | 610-4 | 610-4-UC | 610-5-UC |
|  | Transport | Hausted 615 | 615-4 | 615-4-UC | 615-5-UC |
|  | Transport | Hausted 800 | 800-4 | 800-4-UC | 800-5-UC |
|  | Transport | Hausted 815 | 815-4 | 815-4-UC | 815-5-UC |
|  | Horizon Youth Series | Hausted 2000 | 2000-4 | 2000-4-UC | 2000-5-UC |
|  | Horizon Youth Series | Hausted 4160 | 4160-4 | 4160-4-UC | 4160-5-UC |

NAMC Stretchers BY SIZE

| NAMC | Size | Taper | Standard 4" | Ultra Comfort 4" | Ultra Comfort 5" |
|---|---------|-----------------------------------|--------------|------------------|------------------|
|  | 24"x76" | 8" taper @ head | 76244-D-8 | 76244-D-8-UC | 76245-D-8-UC |
|  | 26"x76" | 8" taper @ head | 76264-D-8 | 76264-D-8-UC | 76265-D-8-UC |
|  | 30"x76" | 8" taper @ head | 76304-D-8 | 76304-D-8-UC | 76305-D-8-UC |
|  | 24"x76" | 12" taper @ head; 4" taper @ foot | 76244-B-12-4 | 76244-B-12-4-UC | 76245-B-12-4-UC |
|  | 26"x76" | 12" taper @ head; 4" taper @ foot | 76264-B-12-4 | 76264-B-12-4-UC | 76265-B-12-4-UC |
|  | 30"x76" | 12" taper @ head; 4" taper @ foot | 76304-B-12-4 | 76304-B-12-4-UC | 76305-B-12-4-UC |

Operating Table Pads

Marathon OR™ Series





Standard Operating Table Pad

Cost-effective performance and patient comfort

Multi-layered, high resiliency foam for added comfort, support, and durability. Designed for shorter procedures or short stay procedural/exam tables.

2" thick CertiPUR-US foam provides comfortable support for individuals up to 300lbs.

- Soft conforming layer
- Supportive foam base layer

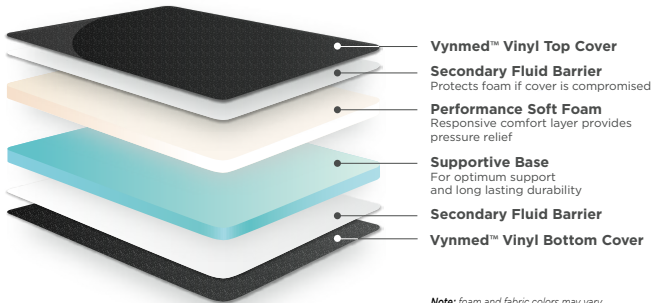

Note: foam and fabric colors may vary

Sealed Seams

- Prevents liquid penetration

Vynmed™ Healthcare Vinyl Cover

- Durable, soft-supple feel offers exceptional comfort
- Anti-bacterial, anti-fungal, water resistant, stain resistant
- Non-allergenic, non-irritating
- Latex free and odor resistant

Secondary Fluid Barrier

- Assembled between foam and cover provides unique protection; if the outer cover is compromised, foam is protected



Secondary Fluid Barrier



CertiPUR-US Foam



12 Month Warranty



Made in the USA



Vynmed™ Cover



Patient Weight Limit



Multi-Layer Performance Foam

Soft Conforming Layer

Firm Supportive Base

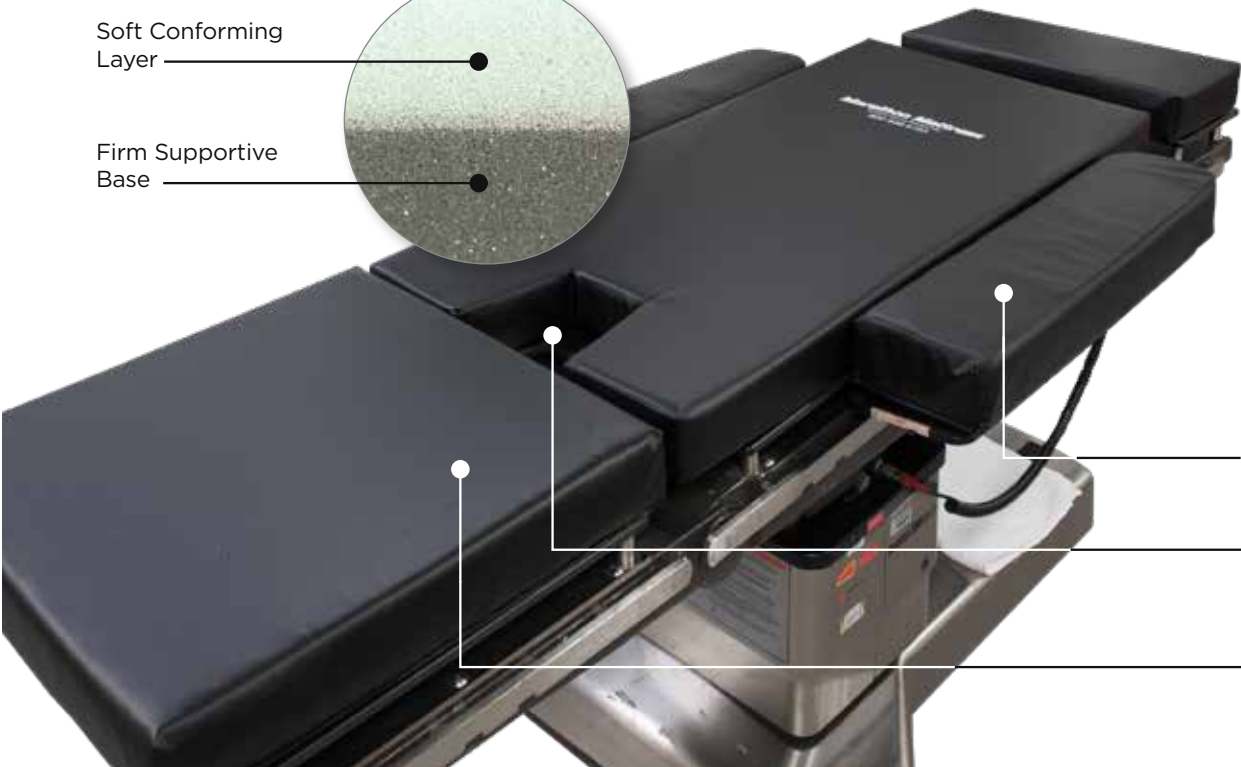
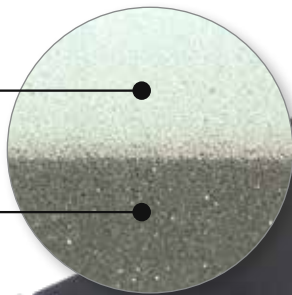

Armboard pads match bed height

Cutout matches the frame opening

Vynmed™ Vinyl Cover

Memory Foam Operating Table Pad

Technology-enhanced for patient comfort



Multi-layered, high resiliency foam for added comfort, support, and durability. Designed for shorter procedures or short stay procedural/exam tables.

3" or 4" thick CertiPUR-US foam provides comfortable support for individuals up to 300lbs.

- Cool Gel infused memory foam top layer
- Performance soft foam internal layer
- Supportive foam base layer

Sealed Seams

- Prevents liquid penetration

Vynmed™ Healthcare Vinyl Cover

- Durable, soft-supple feel offers exceptional comfort
- Anti-bacterial, anti-fungal, water resistant stain resistant
- Non-allergenic, non-irritating
- Latex free and odor resistant

Secondary Fluid Barrier

- Assembled between foam and cover provides unique protection; if the outer cover is compromised, foam is protected

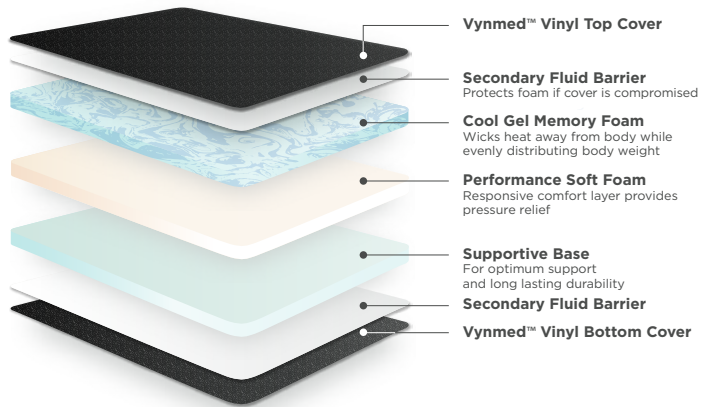

Note: foam and fabric colors may vary

Cool Gel
Memory Foam

Soft Conforming
Foam

Firm Supportive
Base

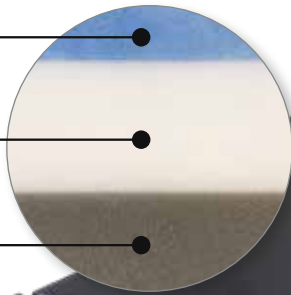

- Secondary Fluid Barrier
- CertiPUR-US Foam
- 12 Month Warranty
- Made in the USA
- Vynmed™ Cover
- Patient Weight Limit
- Cool Gel Memory Foam
- Multi-Layer Performance Foam

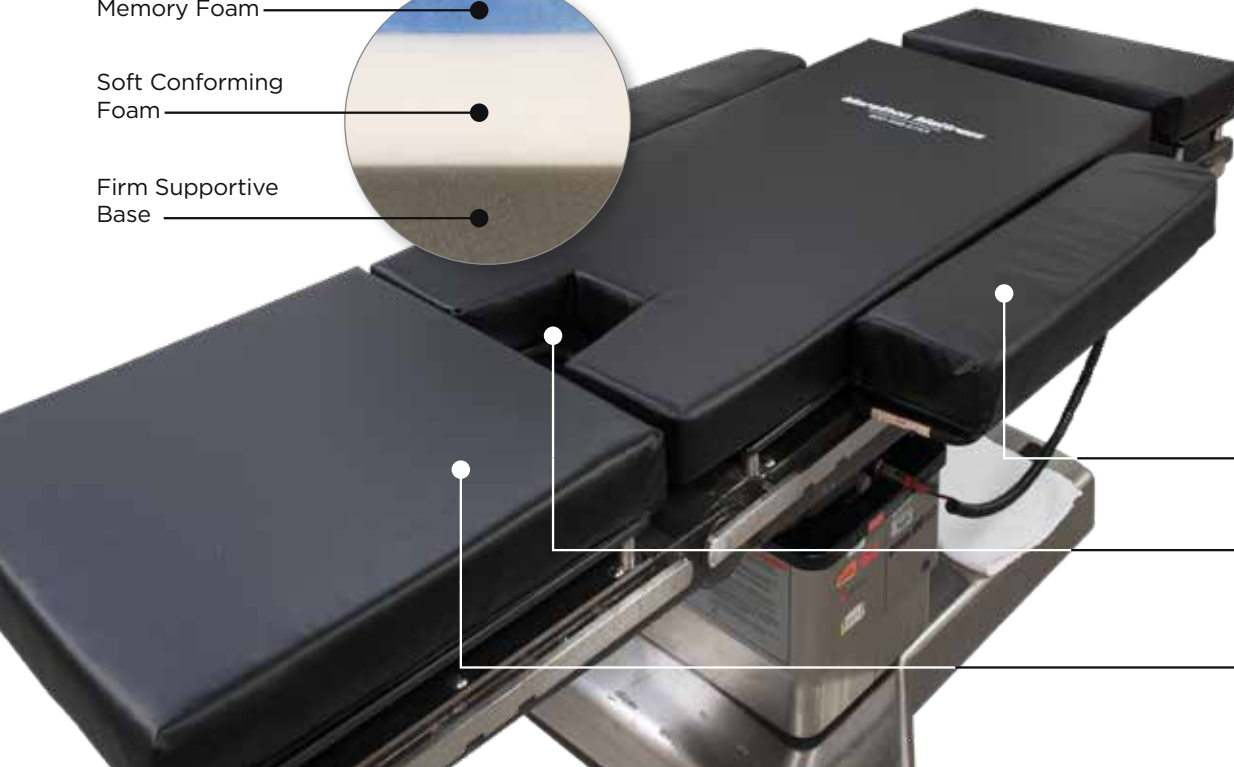

Armboard pads match
bed height

Cutout matches the
frame opening

Vynmed™ Vinyl cover

Operating Table Pads

| Marathon Mattress | Model | Standard | Ultra Comfort |
|---|---|--|--|
|  | Amsco 1080 / 2080 V-Style Mattress (3 piece set) | 5701-2 (2" Thick) 5701-3 (3" Thick) | 5701-3-UC (3" Thick) 5701-4-UC (4" Thick) |
|  | Amsco 3080 V-Style Mattress (3 piece set) | 3080-2 (2" Thick) 3080-3 (3" Thick) | 3080-3-UC (3" Thick) 3080-4-UC (4" Thick) |
|  | Amsco 3085 Mattress (3 piece set) | 3085-2 (2" Thick) 3085-3 (3" Thick) | 3085-3-UC (3" Thick) 3085-4-UC (4" Thick) |
|  | Skytron 5000 / 6000 Mattress (3 piece set) | 6000-2 (2" Thick) | 6000-4-UC (4" Thick) |
|  | Shampaine 4900 Mattress (3 piece set) | 5712-2 (2" Thick) | 5712-4-UC (4" Thick) |
|  | Amsco 3080 Armboard (pair) | 3080-2-AB (2") 3080-3-AB (3") 3080-4-AB (4") | 3080-3-AB-UC (3" Thick) 3080-4-AB-UC (4" Thick) |
|  | Amsco 3085 Armboard (pair) | 3085-2-AB (2") 3085-3-AB (3") 3085-4-AB (4") | 3085-3-AB-UC (3" Thick) 3085-4-AB-UC (4" Thick) |
|  | Skytron 5501 Armboard (pair) | 5501-2-AB (2") 5501-3-AB (3") 5501-4-AB (4") | 5501-3-AB-UC (3" Thick) 5501-4-AB-UC (4" Thick) |



X-Ray, Angio & Cath Lab

Designed for those shorter procedures or short stay procedural/exam tables

Secondary Fluid Barrier

- Assembled between foam and cover provides a unique protection; if the outer layer is compromised, foam is protected

Vynmed™ Healthcare Vinyl Cover

- Anti-bacterial, anti-fungal, water & stain resistant
- Non-allergenic, non-irritating
- Phthalate free, latex free and odor resistant

STANDARD X-RAY/ANGIO PADS

- 2" thick CertiPUR-US foam provides comfortable support for individual's up to 300lbs.
- Soft Conforming foam layer
- Supportive foam base layer

ULTRA COMFORT X-RAY/ANGIO PADS

- 2" or 3" thick CertiPUR-US foam provides comfortable support for individual's up to 300lbs.
- Cool Gel infused memory foam layer will evenly distribute body weight and cooler sleep experience
- Supportive foam base layer

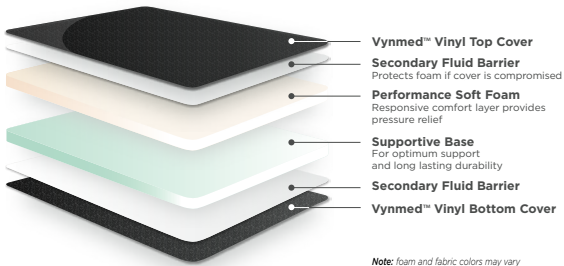

Note: foam and fabric colors may vary

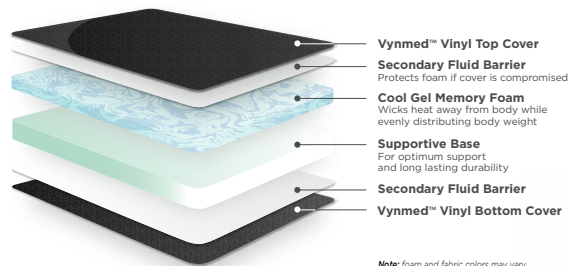

Note: foam and fabric colors may vary



Sealed Seams



Vynmed™ Vinyl Cover



Patient Weight Limit



Secondary Fluid Barrier



12 Month Warranty



Made in the USA

STANDARD ECHO PADS

- 6" thick CertiPUR-US foam provides comfortable support for individual's up to 300lbs.
- Soft Conforming foam layer
- Supportive foam base layer
- Includes removable insert to manipulate transducer for optimal visualization

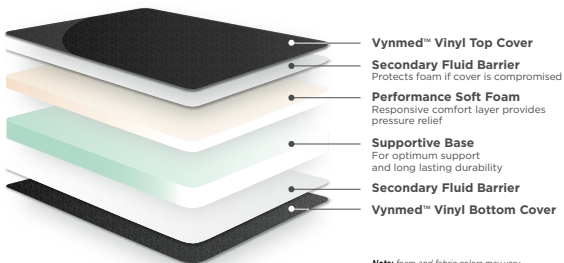

Note: foam and fabric colors may vary

Various shapes available



X-Ray/Angio and Echo Pads

Standard X-Ray/Angio Pads

| Model | Order No. |
|--|-----------|
| Standard Phillips 134 (95" X 22") | 61-2855 |
| Standard GE Omega (118" X 26") | 61-2745 |
| Standard XRE Angio 2 Table Pad (131.5" X 26.5") | 61-8621 |
| Standard Toshiba Cath Lab Table Pad (85.5" X 28") | 61-2588 |

Ultra Comfort X-Ray/Angio Pads

| Model | Order No. |
|---|------------|
| Secure Core Siemens Koordinat 3 (85" X 29") | 61-2961-UC |
| Secure Core GE Omega (118" X 26") | 61-2745-UC |
| Secure Core XRE Angio 2 Table Pad (131.5" X 26.5") | 61-8621-UC |
| Secure Core Toshiba Cath Lab Table Pad (85.5" X 28") | 61-2588-UC |

Standard Echo Pads

| Model | Order No. |
|---|---------------------|
| Standard Echo Pad (75" X 24.5") w/removable insert | 7524.56-B-12-4-ECHO |

Call for additional models

Comfort Overlay Pads

Securely attaches over existing mattress



Standard Comfort Overlay Pad

Patients appreciate outstanding comfort
Fits Labor and Delivery and all beds



Designed to attach securely over an existing mattress assuring outstanding comfort and durability with no slipping or shifting.

3" thick CertiPUR-US foam provides comfortable support for individual's up to 300lbs.

- 3" soft lofted engineered top layer

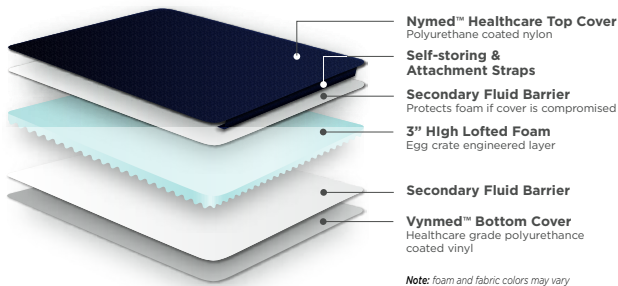

- **Nymed™ Healthcare Top Cover**
Polyurethane coated nylon
- **Self-storing & Attachment Straps**
- **Secondary Fluid Barrier**
Protects foam if cover is compromised
- **3" High Lofted Foam**
Egg crate engineered layer
- **Secondary Fluid Barrier**
- **Vynmed™ Bottom Cover**
Healthcare grade polyurethane coated vinyl

Note: foam and fabric colors may vary

Nymed™ Healthcare Grade Nylon Top Cover

- Water resistant
- Anti-bacterial, anti-fungal, non-allergenic
- Non-irritating, latex free

Vynmed™ Healthcare Vinyl Bottom Cover

- Anti-bacterial, anti-fungal, water & stain resistant
- Non-allergenic, non-irritating
- Latex free and odor resistant

Secondary Fluid Barrier

- Assembled between foam and cover provides a unique protection; if the outer layer is compromised, foam is protected

Removable Cover

- Heavy duty zipper on bottom allows for internal mattress inspection and easy replacement
- Includes fluid protection flap over zipper which directs fluids over and away from the zipper area

Easy Storage

- Self storing straps make storing easy and convenient

Birthing Bed shown, many sizes available.



Self-storing & Attachment Straps

Nymed™ Nylon Top Cover

Vynmed™ Vinyl Cover

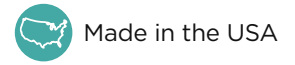
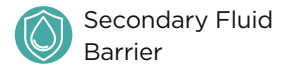
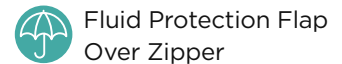
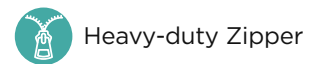
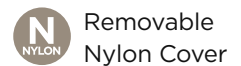
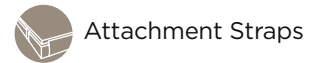
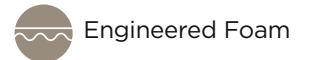
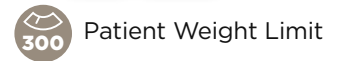

Ultra Comfort Overlay Pad

Patients appreciate outstanding comfort
Fits Labor and Delivery and all beds



Designed to attach securely over an existing mattress assuring outstanding comfort and durability with no slipping or shifting.

3" thick CertiPUR-US foam provides comfortable support for individual's up to 300lbs.

- Cool Gel infused memory foam top layer
- Performance soft foam internal layer
- Supportive foam base layer

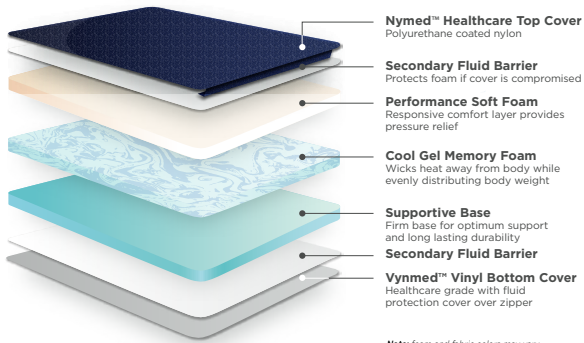

Nymed™ Healthcare Grade Nylon Top Cover

- Water resistant
- Anti-bacterial, anti-fungal, non-allergenic
- Non-irritating, latex free

Vynmed™ Healthcare Vinyl Bottom Cover

- Anti-bacterial, anti-fungal, water & stain resistant
- Non-allergenic, non-irritating
- Latex free and odor resistant

Secondary Fluid Barrier

- Assembled between foam and cover provides a unique protection; if the outer layer is compromised, foam is protected

Removable Cover

- Heavy duty zipper on bottom allows for internal mattress inspection and easy replacement
- Includes fluid protection flap over zipper which directs fluids over and away from the zipper area

Easy Storage

- Self storing straps make storing easy and convenient

Birthing Bed shown, many sizes available.



Self-storing & Attachment Straps

Nymed 6™ Nylon Top Cover

Vynmed™ Vinyl Bottom Cover

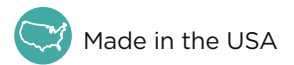
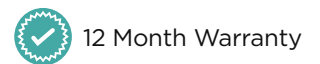
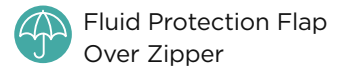
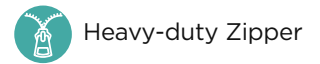
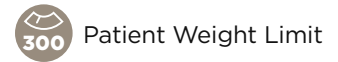
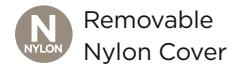
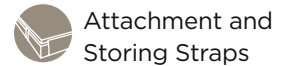
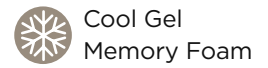

Comfort Overlay Pads

Patients value exceptional comfort, and our Marathon Overlay delivers just that. Whether it's for extended stays or simply enhancing the comfort of a bed or stretcher, our overlay is the solution. Engineered to be secure, durable, and budget-friendly, it offers a superior experience.

Our Comfort Pads are meticulously crafted to easily attach over existing mattresses, ensuring unparalleled comfort and longevity without any slipping or shifting. The overlay can be conveniently stored using the retention straps, making storage hassle-free. Featuring a top cover made of Nymed™ healthcare nylon and a bottom cover of Vynmed™ healthcare polyurethane coated vinyl, our product provides a resilient, anti-static, stain-resistant, and non-allergenic mattress cover.

| Size | Standard Overlay | Ultra Comfort Overlay |
|---|------------------|-----------------------|
| 81"x33"x3" (Fits Labor and Delivery Model 304) | 26-304 | 26-304-UC |
| 76"x36"x3" | 26-2612 | 26-2612-UC |
| 76.5"x34.5"x3" | 26-2610 | 26-2610-UC |
| 76"x33"x3" | 26-2602 | 26-2602-UC |
| 77"x31"x3" | 26-2624 | 26-2624-UC |
| 78"x34.5"x3" | 26-2608 | 26-2608-UC |
| 78"x36"x3" | 26-2623 | 26-2623-UC |
| 79"x36"x3" (Fits Affinity I, II, III, & IV) (Fits Labor and Delivery Models) | 26-2620 | 26-2620-UC |
| 80"x35"x3" | 26-80353 | 26-80353-UC |
| 80"x36"x3" | 26-80363 | 26-80363-UC |
| 76"x26"x3" | 26-76263 | 26-76263-UC |
| 76"x30"x3" | 26-76303 | 26-76303-UC |

General Patient and ICU/CCU

Quality to go the distance™



General Hospital Mattress Collection

Step up to the Marathon™ Series Advanced Care Mattresses from our General Hospital Mattress Collection. Engineered with the unique requirements of longer-stay and high-risk patients in focus, our mattresses offer unparalleled support and comfort.

Whether you opt for the Advanced Care™ or the Assure II™, both models are meticulously

designed to address the needs of patients, particularly in preventing pressure ulcers.

Experience the comfort and luxury with our deluxe Advanced Care™ mattress, featuring Vistotech™ gel memory foam for superior support and relaxation. Alternatively, for patients at higher risk, the Assure II™ offers a high loft, convoluted foam top, ensuring optimal comfort and support.

| Features | Assure II™ | Advanced Care™ | Standard Bariatric Assure II (500) | Heavy Duty Bariatric Assure II (1000) | Standard Bariatric Advanced Care (500) | Heavy Duty Bariatric Advanced Care (1000) |
|---|------------|----------------|------------------------------------|---------------------------------------|--|---|
| Cool Gel Infused Memory Foam | | x | | | x | x |
| Water Resistant Cover | x | x | x | x | x | x |
| Secondary Fluid Barrier (protects foam if outer layer is compromised) | x | x | x | x | x | x |
| Removable Cover | x | x | x | x | x | x |
| Fluid Protection Flap Over Zipper | x | x | x | x | x | x |
| Easy to Clean | x | x | x | x | x | x |
| FirmEdge™ Passive Restraint System | x | x | x | x | x | x |
| Weight Capacity | 300lbs | 300lbs | 500lbs | 1000lbs | 500lbs | 1000lbs |
| USA Made Foam | x | x | x | x | x | x |
| CertiPUR-US Certified Foam | x | x | x | x | x | x |



Assure II™

General Patient and ICU/CCU Hospital Mattress

Multi-layered, multi-density for optimal comfort and postural support

6" thick CertiPUR-US foam provides comfortable support for individual's up to 300lbs.

- 2" soft lofted engineered top layer
- Performance soft foam internal layer
- Supportive firm foam base layer

FirmEdge™ Passive Restraint System

- Provides support on both sides of the mattress during entry and egress

Nymed™ Healthcare Grade Nylon Top Cover

- Water resistant, flame resistant
- Anti-bacterial, anti-fungal, non-allergenic
- Non-irritating, latex free

Vynmed™ Healthcare Vinyl Bottom Cover

- Anti-bacterial, anti-fungal, water & stain resistant
- Non-allergenic, non-irritating
- Latex free and odor resistant

Secondary Fluid Barrier

- Assembled between foam and cover provides a unique protection; if the outer layer is compromised, foam is protected

Removable Cover

- Heavy duty zipper on bottom allows for internal mattress inspection and easy replacement
- Includes fluid protection flap over zipper which directs fluids over and away from the zipper area

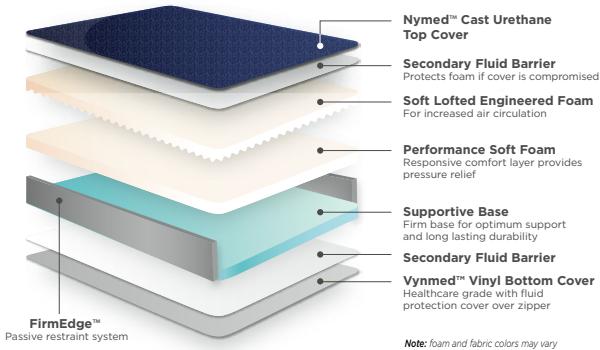

Soft Lofted Engineered Foam

Performance Soft Layer

Supportive Base

FirmEdge™ Passive Restraint System

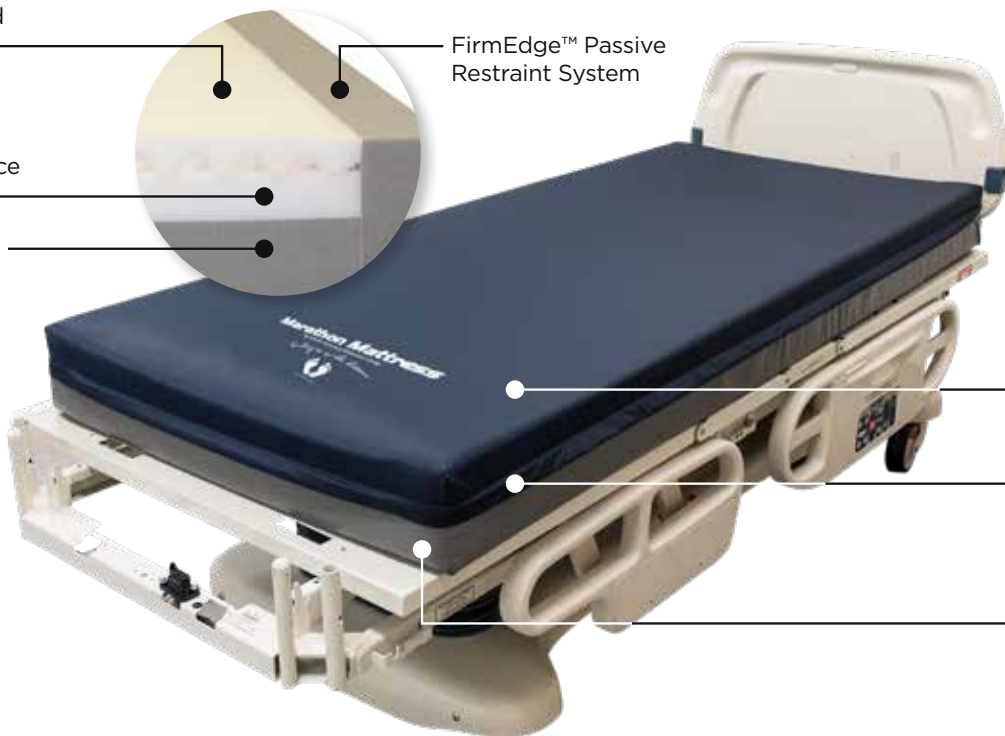

Nymed™ Nylon Top Cover

Fluid Flap Over Heavy-Duty Zipper

Vynmed™ Vinyl Bottom Cover

- Heavy-duty Zipper
- Fluid Protection Flap Over Zipper
- Flame Resistant
- Secondary Fluid Barrier
- CertiPUR-US Foam
- 12 Month Warranty
- Made in the USA
- Removable Nylon Cover
- Patient Weight Limit
- Multi-Layer Performance Foam
- FirmEdge™ Passive Restraint



Advanced Care™

General Patient and ICU/CCU Hospital Mattress with Cool Gel Memory Foam

Select the high comfort and unmatched luxury of our deluxe Advanced Care™ pressure reduction mattress for higher risk patients

6" thick CertiPUR-US foam provides comfortable support for individual's up to 300lbs.

- Cool Gel infused memory foam top layer
- Performance soft foam internal layer
- Supportive firm foam base layer

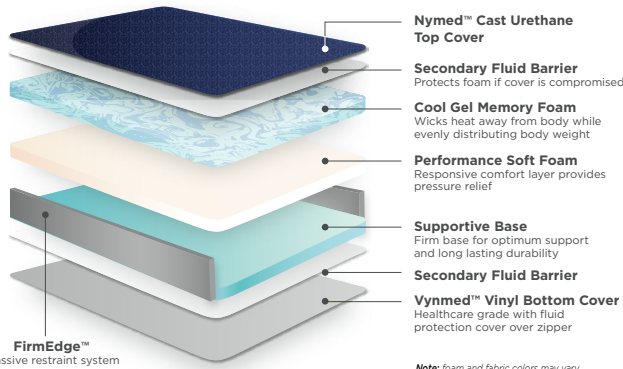

Note: foam and fabric colors may vary

FirmEdge™ Passive Restraint System

- Provides support on both sides of the mattress during entry and egress

Nymed™ Healthcare Grade Nylon Top Cover

- Water resistant, flame resistant
- Anti-bacterial, anti-fungal, non-allergenic
- Non-irritating, latex free

Vynmed™ Healthcare Vinyl Bottom Cover

- Anti-bacterial, anti-fungal, water & stain resistant
- Non-allergenic, non-irritating
- Latex free and odor resistant

Secondary Fluid Barrier

- Assembled between foam and cover provides a unique protection; if the outer layer is compromised, foam is protected

Removable Cover

- Heavy duty zipper on bottom allows for internal mattress inspection and easy replacement
- Includes fluid protection flap over zipper which directs fluids over and away from the zipper area

Cool Gel Memory Foam

Performance Soft Layer

Supportive Base

FirmEdge™ Passive Restraint System

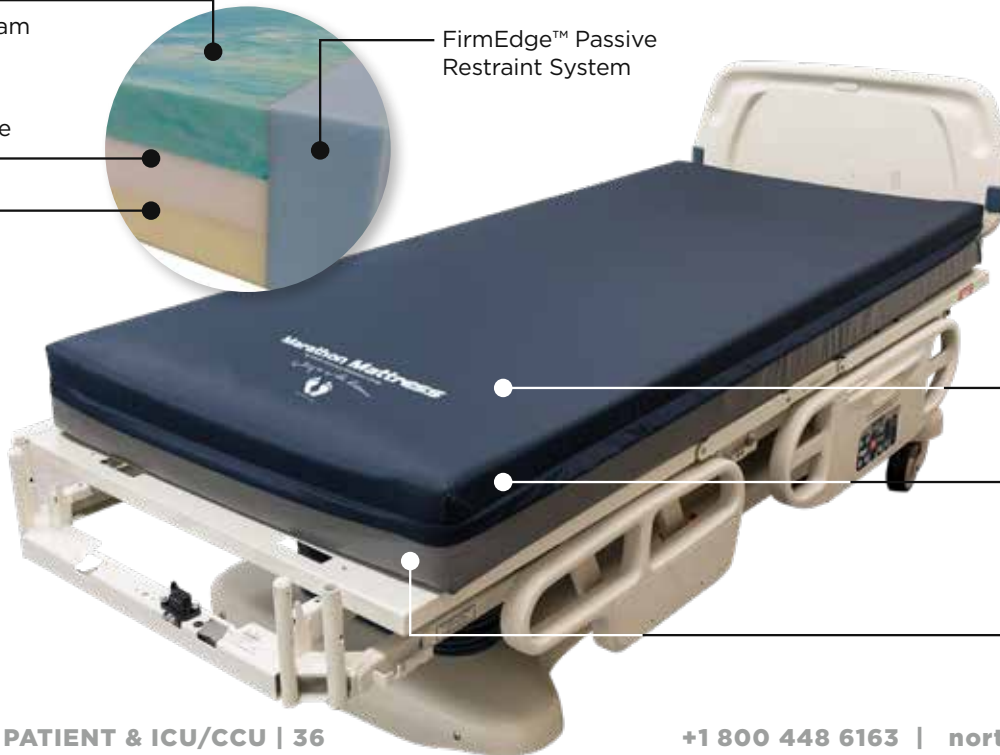

Cool Gel Memory Foam

FirmEdge™ Passive Restraint

Heavy-duty Zipper

Fluid Protection Flap Over Zipper

Flame Resistant

Secondary Fluid Barrier

CertiPUR-US Foam

12 Month Warranty

Made in the USA

Removable Nylon Cover

Patient Weight Limit

Carrying Handles

Nymed™ Nylon Top Cover

Fluid Flap Over Heavy-Duty Zipper

Vynmed™ Vinyl Bottom Cover

General Hospital Mattresses

Standard (Weights up to 300lbs) By Size

| Size | Assure II | Advanced Care | Size | Assure II | Advanced Care | Size | Assure II | Advanced Care |
|------------|-----------|---------------|------------|-----------|---------------|------------|-----------|---------------|
| 72"x36"x6" | 42-72366 | 44-72366 | 80"x33"x6" | 42-80336 | 44-80336 | 82"x36"x6" | 42-82366 | 44-82366 |
| 74"x38"x6" | 42-74386 | 44-74386 | 80"x34"x6" | 42-80346 | 44-80346 | 82"x38"x6" | 42-82386 | 44-82386 |
| 75"x35"x6" | 42-75356 | 44-75356 | 80"x35"x6" | 42-80356 | 44-80356 | 84"x32"x6" | 42-84326 | 44-84326 |
| 76"x35"x6" | 42-76356 | 44-76356 | 80"x36"x6" | 42-80366 | 44-80366 | 84"x34"x6" | 42-84346 | 44-84346 |
| 78"x35"x6" | 42-78356 | 44-78356 | 80"x38"x6" | 42-80386 | 44-80386 | 84"x35"x6" | 42-84356 | 44-84356 |
| | | | 82"x35"x6" | 42-82356 | 44-82356 | 84"x36"x6" | 42-84366 | 44-84366 |

Standard (Weights up to 300lbs) By OEM

| Model | Assure II | Advanced Care |
|---|-----------|---------------|
| Stryker Secure II Standard Replacement Mattress | 42-84356 | 44-84356 |
| Stryker Acute Care 72" long Standard Replacement Mattress | 42-72366 | 44-72366 |
| Stryker Acute Care 80" long Standard Replacement Mattress | 42-80366 | 44-80366 |
| Stryker Acute Care 84" long Standard Replacement Mattress | 42-84366 | 44-84366 |
| Stryker Go bed 84" long Standard Replacement Mattress | 42-84366 | 44-84366 |
| Hill-Rom Advanced 2000 Standard Replacement Mattress | 42-82366 | 44-82366 |
| Hill-Rom Advanced 1000 Standard Replacement Mattress | 42-82366 | 44-82366 |
| Hill-Rom Centra 850 Standard Replacement Mattress | 42-82366 | 44-82366 |
| Hill-Rom model 840 Standard Replacement Mattress | 42-82366 | 44-82366 |
| Hill-Rom model 835, 820 and Century Standard Replacement Mattress | 42-80366 | 44-80366 |
| Hill-Rom model 820 Standard Replacement Mattress | 42-80366 | 44-80366 |
| Hill-Rom Century Standard Replacement Mattress | 42-80366 | 44-80366 |



Bariatric Assure II™

General Patient and ICU/CCU Hospital Mattress

Multi-layered, Multi-density for optimal comfort and postural support. Models supporting weights up to 500lbs or 1000lbs.

7" thick Certi-PUR-US foam provides comfortable support for individual's up to 500 or 1000lbs.

- Soft top layer
- Medium conforming layer
- Semi-firm internal layer
- Performance foam base layer"

FirmEdge™ Passive Restraint System

- Provides support on both sides of the mattress during entry and egress

Nymed™ Healthcare Grade Nylon Top Cover

- Water resistant, flame resistant
- Anti-bacterial, anti-fungal, non-allergenic
- Non-irritating, latex free

Vynmed™ Healthcare Vinyl Bottom Cover

- Anti-bacterial, anti-fungal, water & stain resistant
- Non-allergenic, non-irritating
- Latex free and odor resistant

Secondary Fluid Barrier

- Assembled between foam and cover provides a unique protection; if the outer layer is compromised, foam is protected

Removable Cover

- Heavy duty zipper on bottom allows for internal mattress inspection and easy replacement
- Includes fluid protection flap over zipper which directs fluids over and away from the zipper area

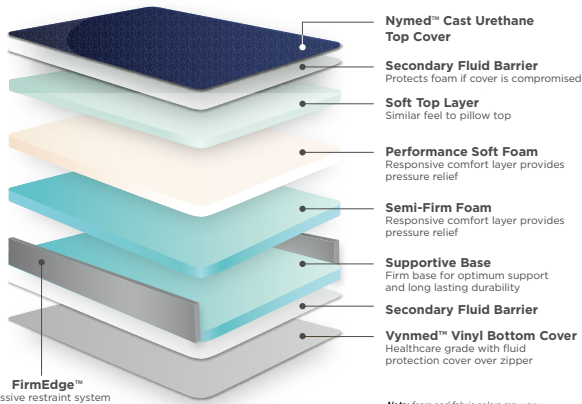

FirmEdge™ Passive restraint system

Note: foam and fabric colors may vary

Soft Foam

Performance Soft Layer

Semi-firm Layer

Supportive Base

FirmEdge™ Passive Restraint System

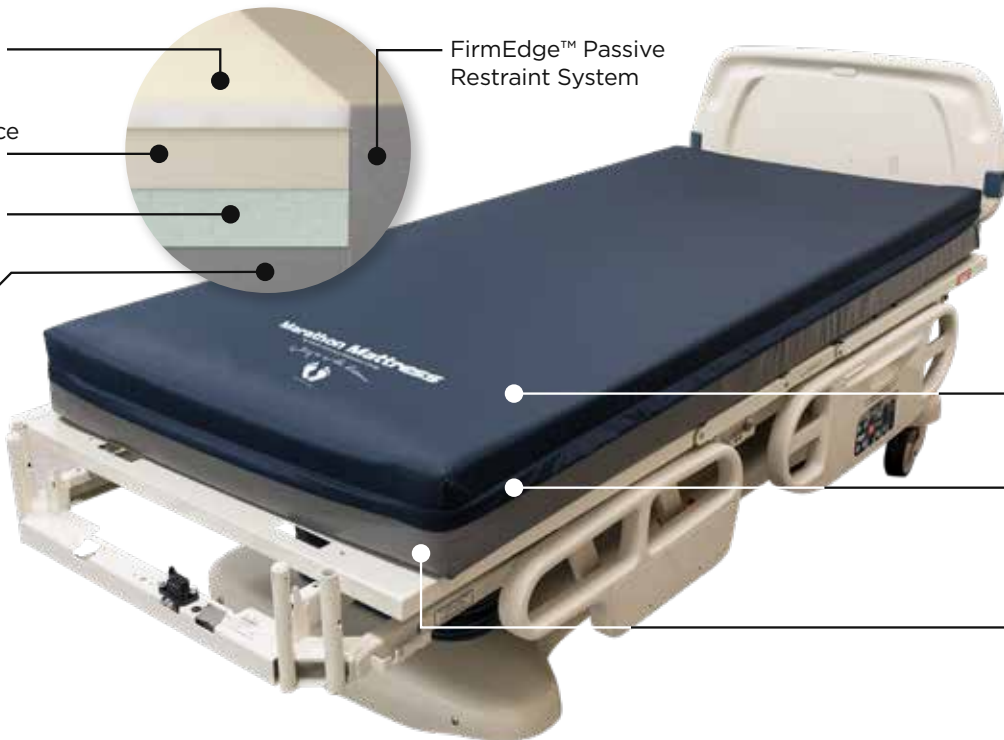

Secondary Fluid Barrier



CertiPUR-US Foam



12 Month Warranty



Made in the USA



Removable Nylon Cover



Patient Weight Limit



Multi-Layer Performance Foam



FirmEdge™ Passive Restraint



Carrying Handles



Heavy-duty zipper



Fluid Protection Flap Over Zipper



Flame Resistant

Nymed™ Nylon Top Cover

Fluid Flap Over Heavy-Duty Zipper

Vynmed™ Vinyl Bottom Cover



Bariatric Advanced Care™

General Patient and ICU/CCU Hospital Mattress with Cool Gel Memory Foam. Models Supporting weights up to 500lbs or 1000lbs.

Select the high comfort and unmatched luxury of our deluxe Bariatric Advanced Care™ pressure reduction mattress for your higher risk patients.

7" thick CertiPUR-US foam provides comfortable support for individual's up to 500 or 1000lbs.

- Cool Gel infused memory foam top layer
- Performance soft foam internal layer
- Semi-firm foam internal layer
- Supportive firm foam base layer

FirmEdge™ Passive Restraint System

- Provides support on both sides of the mattress during entry and egress

Nymed™ Healthcare Grade Nylon Top Cover

- Water resistant, flame resistant
- Anti-bacterial, anti-fungal, non-allergenic
- Non-irritating, latex free

Vynmed™ Healthcare Vinyl Bottom Cover

- Anti-bacterial, anti-fungal, water & stain resistant
- Non-allergenic, non-irritating
- Latex free and odor resistant

Secondary Fluid Barrier

- Assembled between foam and cover provides a unique protection; if the outer layer is compromised, foam is protected

Removable Cover

- Heavy duty zipper on bottom allows for internal mattress inspection and easy replacement
- Includes fluid protection flap over zipper which directs fluids over and away from the zipper area

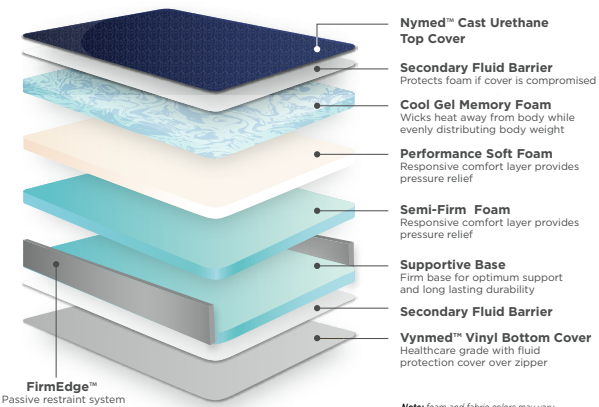

Note: foam and fabric colors may vary

Cool Gel Memory Foam

Performance Soft Layer

Semi-firm Layer

Supportive Base

FirmEdge™ Passive Restraint System

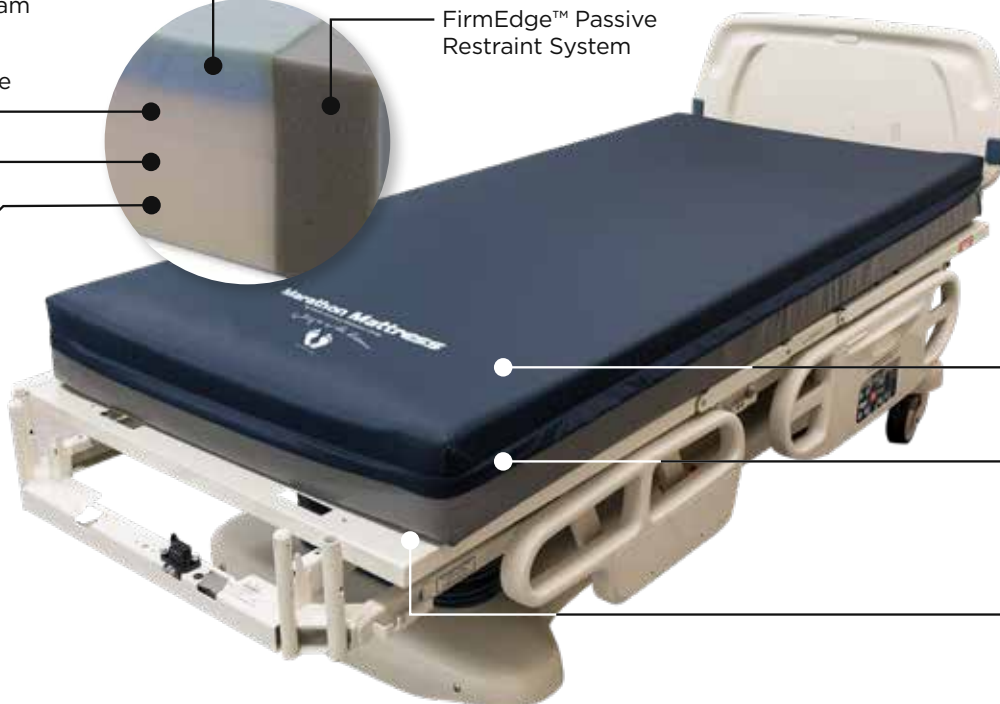

Secondary Fluid Barrier



CertiPUR-US Foam



12 Month Warranty



Made in the USA



Removable Nylon Cover



Patient Weight Limit



Cool Gel Memory Foam



FirmEdge™ Passive Restraint



Carrying Handles



Heavy-duty zipper



Fluid Protection Flap Over Zipper



Flame Resistant

Nymed™ Nylon Top Cover

Fluid Flap Over Heavy-Duty Zipper

Vynmed™ Vinyl Bottom Cover

Bariatric General Hospital Mattresses

Standard Bariatric (Weights up to 500lbs)

| Size | Bariatric Assure II | Bariatric Advanced Care |
|--------------------------------------|---------------------|-------------------------|
| 72"x36"x7" 500lbs | 42-HD-72367 | 44-HD-72367 |
| 80"x34"x7" 500lbs | 42-HD-80347 | 44-HD-80347 |
| 80"x35"x7" 500lbs | 42-HD-80357 | 44-HD-80357 |
| 80"x36"x7" 500lbs | 42-HD-80367 | 44-HD-80367 |
| 80"x39"x7" 500lbs | 42-HD-80397 | 44-HD-80397 |
| 80"x42"x7" (Wide) 500lbs | 42-HD-80427 | 44-HD-80427 |
| 80"x48"x7" (Extra Wide) 500lbs | 42-HD-80487 | 44-HD-80487 |
| 82"x35"x7" 500lbs | 42-HD-82357 | 44-HD-82357 |
| 84"x34"x7" 500lbs | 42-HD-84347 | 44-HD-84347 |
| 84"x35"x7" 500lbs | 42-HD-84357 | 44-HD-84357 |
| 84"x36"x7" 500lbs | 42-HD-84367 | 44-HD-84367 |

Heavy Duty Bariatric (Weights up to 1000lbs)

| Size | Bariatric Assure II | Bariatric Advanced Care |
|---------------------------------------|---------------------|-------------------------|
| 72"x36"x7" 1000lbs | 42-HDM-72367 | 44-HDM-72367 |
| 80"x34"x7" 1000lbs | 42-HDM-80347 | 44-HDM-80347 |
| 80"x35"x7" 1000lbs | 42-HDM-80357 | 44-HDM-80357 |
| 80"x36"x7" 1000lbs | 42-HDM-80367 | 44-HDM-80367 |
| 80"x39"x7" 1000lbs | 42-HDM-80397 | 44-HDM-80397 |
| 80"x42"x7" (Wide) 1000lbs | 42-HDM-80427 | 44-HDM-80427 |
| 80"x48"x7" (Extra Wide) 1000lbs | 42-HDM-80487 | 44-HDM-80487 |
| 82"x35"x7" 1000lbs | 42-HDM-82357 | 44-HDM-82357 |
| 84"x34"x7" 1000lbs | 42-HDM-84347 | 44-HDM-84347 |
| 84"x35"x7" 1000lbs | 42-HDM-84357 | 44-HDM-84357 |
| 84"x36"x7" 1000lbs | 42-HDM-84367 | 44-HDM-84367 |



V36™ Deck Bed

Fits the VersaCare® Bed

Compressible foot section adds length, flexibility and accommodates frame expansion/retraction

Dimensions: 86" X 35" X 8"

Retracts to: 75" X 35" X 8"

Model Number: 44-V36

Nymed 6™ Healthcare Grade Stretchable Cast Coated Polyurethane Top Cover:

Designed for patient comfort and clinical efficacy:

- Low friction for ease of patient transfers
- Anti-microbial, anti-static, stain resistant, abrasion resistant
- Non-allergenic, latex free, water resistant

Tri-Zone Foam Construction:

3 independently designed zones:
Head Zone, Seat Zone, Foot Zone

Foam Layers

- Soft plush foam top layer
- Cool Gel infused soft conforming memory foam layer
- Internal supportive middle layer
- Ultra-high density firm base layer

Bottom Cover:

Durable bottom non-skid vinyl cover that is tear resistant and extends mattress performance.

4 built-in carrying handles

that are conveniently located for mattress handling; (includes cleanable coated webbing).

Retracts to 75" x 35" x 8"

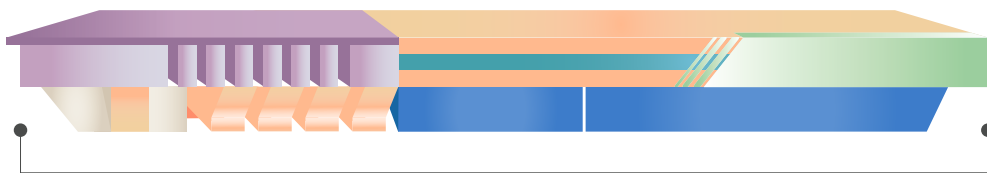
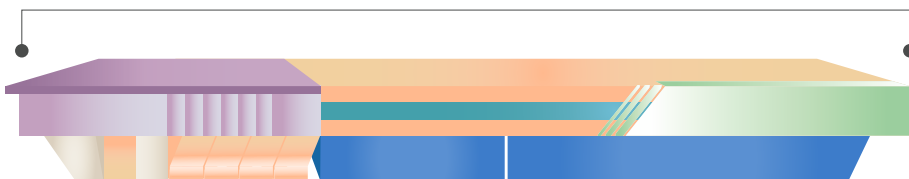

Expands to 86" x 35" x 8"

Note: foam and fabric colors may vary



Made in the USA



**All foam
CertiPUR-US
certified**

Side Rail Pads

Models to fit all major brands



Our standard Side Rail Pads attach securely over existing siderails with no shifting and are easily removed when needed.

Vynmed™ Healthcare Vinyl Cover

- Anti-bacterial, anti-fungal, water & stain resistant
- Non-allergenic, non-irritating
- Phthalate free, latex free and odor resistant

CertiPUR-US foam

- Firm foam core offers some protection for patients

Medical Grade Attachment Straps with Stainless Steel Snaps

- Help prevent shifting and ensure the side rail pads are attached securely (depends on models)

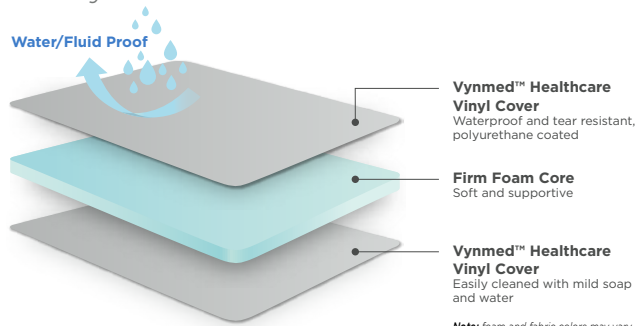

Note: foam and fabric colors may vary

 CertiPUR-US Foam

 12 Month Warranty

 Made in the USA

 Vynmed™ Cover

Side Rail Pads for Beds (4 pad models)



Clear vinyl over controls for easy cleaning and protection

Side Rail Pads for Stretchers (2 pad models)



Side Rail Pads

| Features | Side Rail Pads for Beds | Side Rail Pads for Stretchers |
|---------------------------------|-------------------------|-------------------------------|
| Sealed Waterproof Cover | x | x |
| Number of Pads in Set | 4 | 2 |
| Easy to Clean | x | x |
| Shear Liner | x | x |
| Latex Free | x | x |
| Medical Grade Attachment Straps | x | x |
| CertiPUR-US Certified Foam | x | x |
| USA Made Foam | x | x |

Side Rail Replacement Pads for Beds

| Model | Order No. |
|--|-----------|
| Stryker GO Bed (4 piece set) | 32-8265 |
| Hill-Rom Advance 2000 (4 piece set) | 32-2000 |
| Hill-Rom Progressa (4 piece set) | 32-P600 |
| Spirit Select (4 piece set) | 32-5700 |
| Stryker Secure II (4 piece set) | 32-8579 |
| Arjo Enterprise 9000 (4 piece set) | 32-E900 |
| Linet Elegana (4 piece set) | 32-7743 |
| Linet Multi-Care (4 piece set) | 32-7761 |
| Stryker in Touch (4 piece set) | 32-8267 |
| Stryker 3002 (4 piece set) | 32-3002 |

Side Rail Replacement Pads for Stretchers

| Model | Order No. |
|---|-----------|
| Stretcher Side Rail Pad Full Length (2 each) | 32-7684 |
| Stretcher Side Rail Pad 3/4 Length (2 each) | 32-6084 |

Labor & Delivery

Stryker Model 304 Beds

Designed for patient comfort and clinical efficacy



Patients will appreciate the exceptional comfort and support of this mattress. You will welcome the durability and performance.

Sealed Seams in high fluid areas.

Nymed 6™ Healthcare Grade Nylon Cover

- Water resistant
- Anti-bacterial, anti-fungal, non-allergenic
- Non-irritating, latex free

Secondary Fluid Barrier

- Assembled between foam and cover provides a unique protection; if the outer layer is compromised, foam is protected

Medical Grade Attachment Straps

- Stainless Steel Snaps on foot section to attach pad to bed when required

HEAD SECTION

- CertiPUR-US foam provides comfortable support for individual's up to 300lbs.
- Soft conforming top layer.
- Cool Gel infused memory foam layer will evenly distribute body weight and cooler sleep experience
- Performance foam internal layer
- Supportive firm foam base layer

FOOT SECTION

- Soft conforming top layer
- Supportive firm foam base layer

 Removable Nylon Cover

 Patient Weight Limit

 Secondary Fluid Barrier

 12 Month Warranty

 Made in the USA

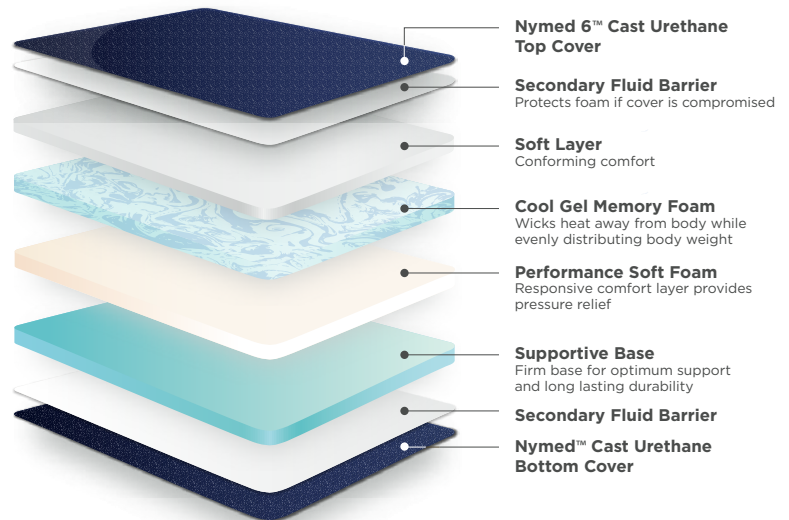

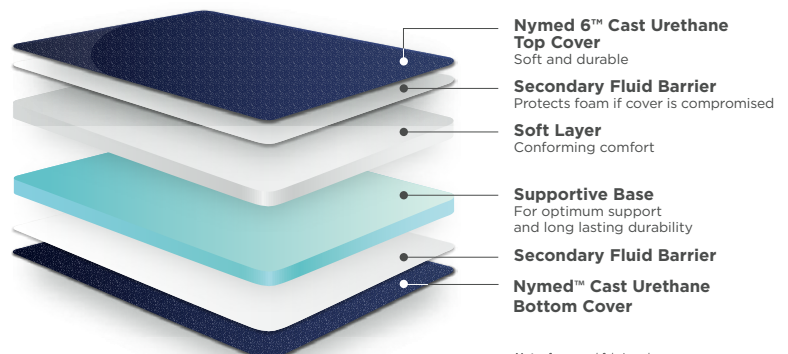

Note: foam and fabric colors may vary



Note: foam and fabric colors may vary

Stryker 304 Birthing Bed

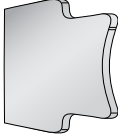
| Stryker | Size | Type | Order No. |
|---|--------------------------------|------|-----------|
|  | Stryker 304 Head Section | Head | 304-H |
|  | Stryker 304 Head Section w/Air | Head | 304-H-Air |
|  | Stryker 304 Foot Section | Foot | 304-F |

Labor & Delivery

Hill-Rom Affinity™ Series Bed

Designed for patient comfort and clinical efficacy



Your patients will appreciate the exceptional comfort and support of this mattress. You will welcome the durability and performance.

Sealed Seams in high fluid areas.

Nymed 6™ Cover

- Durable, soft-supple feel offers exceptional comfort
- Anti-bacterial, anti-fungal, water resistant, stain resistant
- Non-allergenic, non-irritating
- Phthalate free, latex free and odor resistant

Secondary Fluid Barrier

- Assembled between foam and cover provides a unique protection; if the outer layer is compromised, foam is protected

Medical Grade Attachment Straps

- Stainless Steel Snaps on foot section to attach pad to bed when required

L&D HEAD SECTION

- 5" thick CertiPUR-US foam provides comfortable support for individual's up to 300lbs.
- Cool Gel infused memory foam layer to evenly distribute body weight and cooler sleep experience
- Performance soft foam internal layer
- Supportive foam base layer

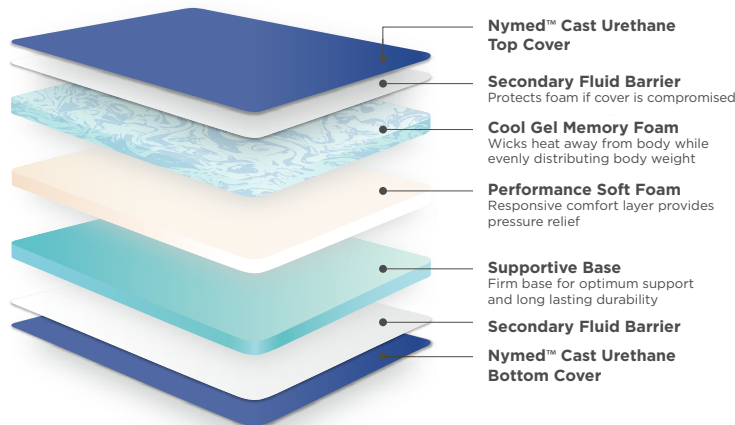

Note: foam and fabric colors may vary

L&D FOOT SECTION

- 3.5" thick CertiPUR-US foam, multi-layered
- Soft conforming layer
- Supportive foam base layer

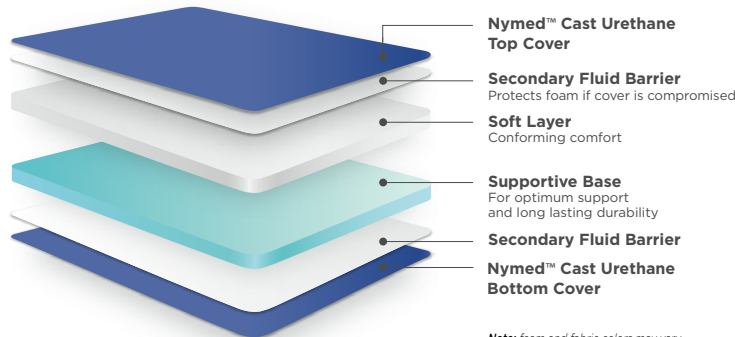



Note: foam and fabric colors may vary

 **Nymed 6™ Waterproof Cover**

 **Patient Weight Limit**

 **Cool Gel Memory Foam (Head Section)**

 **Attachment Straps**





 **Secondary Fluid Barrier**

 **CertiPUR-US Foam**

 **12 Month Warranty**

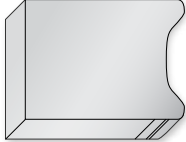
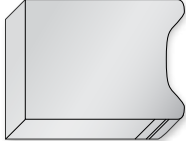
 **Made in the USA**

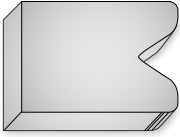
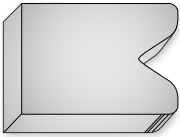
Hill-Rom Affinity & Affinity II Series

| Hill-Rom | Size | Type | Order No. |
|---|--|------|-----------|
|  | Hill-Rom Affinity & Affinity II Straight Head Section | Head | 3613 |
|  | Hill-Rom Affinity & Affinity II Straight Head Section w/Air | Head | 3611-AIR |
|  | Hill-Rom Affinity & Affinity II Straight Foot Section - w/folds | Foot | 3612-F |
|  | Hill-Rom Affinity & Affinity II V-Cut Head Section | Head | 3617 |
|  | Hill-Rom Affinity & Affinity II V-Cut Head Section w/Air | Head | 3615-AIR |
|  | Hill-Rom Affinity & Affinity II V-Cut Foot Section w/folds | Foot | 3616-F |

Hill-Rom Affinity III & IV Series

| Hill-Rom | Size | Type | Order No. |
|---|--|------|----------------|
|  | Hill-Rom Affinity III & Affinity IV Straight Head Section | Head | 3627 |
|  | Hill-Rom Affinity III & Affinity IV Straight Head Section w/ Air Head | Head | 3627-AIR |
|  | Hill-Rom Affinity III & Affinity IV Straight Double Cover Head Section (includes cover and slip cover) | Head | 3627-DBCVR |
|  | Hill-Rom Affinity III & Affinity IV Straight Head Section w/ Air Head & Double Cover (includes cover and slip cover) | Head | 3627-AIR-DBCVR |
|  | Hill-Rom Affinity III & Affinity IV Straight Head Section - Slip Cover Only | Head | 3627-OVC-CVR |
|  | Hill-Rom Affinity III & Affinity IV Straight Foot Section w/folds & Double Cover (includes cover and slip cover, does not include bottom hook) | Foot | 3626-F |
|  | Hill-Rom Affinity III & Affinity IV Straight Foot Section w/folds - Slip Cover Only | Foot | 3626-OVC-CVR |
|  | Hill-Rom Affinity III & Affinity IV V-Cut Head Section | Head | 3623 |
|  | Hill-Rom Affinity III & Affinity IV V-Cut Head Section w/ Air Head | Head | 3623-AIR |
|  | Hill-Rom Affinity III & Affinity IV V-Cut Double Cover Head Section (includes cover and slip cover) | Head | 3623-DBCVR |
|  | Hill-Rom Affinity III & Affinity IV V-Cut Head Section w/ Air Head & Double Cover (includes cover and slip cover) | Head | 3623-AIR-DBCVR |
|  | Hill-Rom Affinity III & Affinity IV V-Cut Head Section - Slip Cover Only | Head | 3623-OVC-CVR |
|  | Hill-Rom Affinity III & Affinity IV V-Cut Foot Section w/folds & Double Cover (includes cover and slip cover, does not include bottom hook) | Foot | 3622-F |
|  | Hill-Rom Affinity III & Affinity IV V-Cut Foot Section w/folds - Slip Cover Only | Foot | 3622-OVC-CVR |



Pediatric Mattresses & Pads

Newborn Crib, Infant Pads & Infant Warmer with Support Insert

You can be confident that your little patients are cozy and comfortable on their Marathon Mattresses™ designed for Bassinets, Cribs, Cradles, Infant Care Stations, and Infant Warmers

Sealed Seams in high fluid areas

Vynmed™ Healthcare Vinyl Cover

- Durable, soft-supple feel offers exceptional comfort
- Phthalate Free
- Water and stain resistant
- Anti-bacterial, anti-fungal
- Non-allergenic, non-irritating
- Latex free and odor resistant

1", 1.5" or 2" thick CertiPUR-US foam

- Soft, supportive conforming foam core

Infant Care Stations

- Many infant warmers require support insert

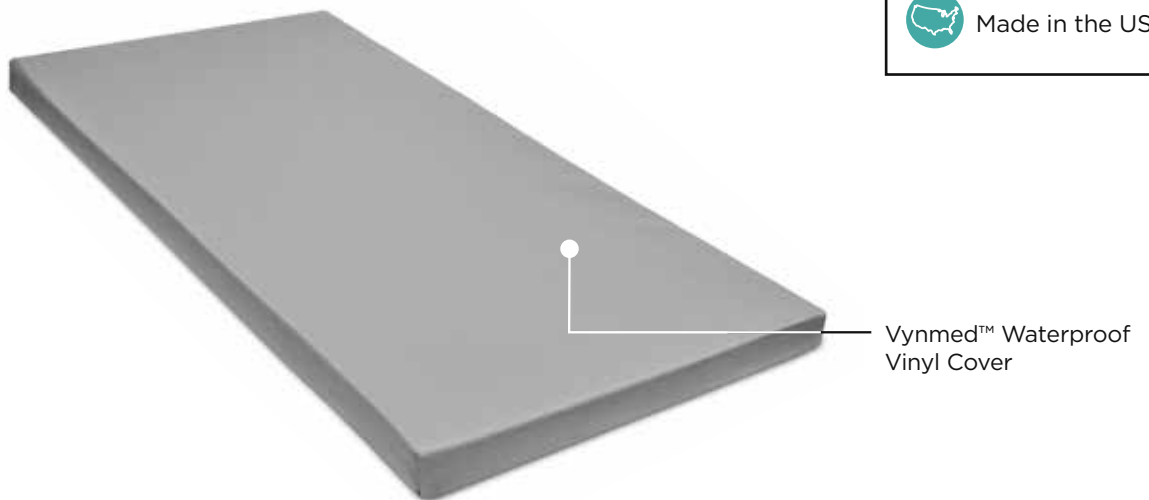
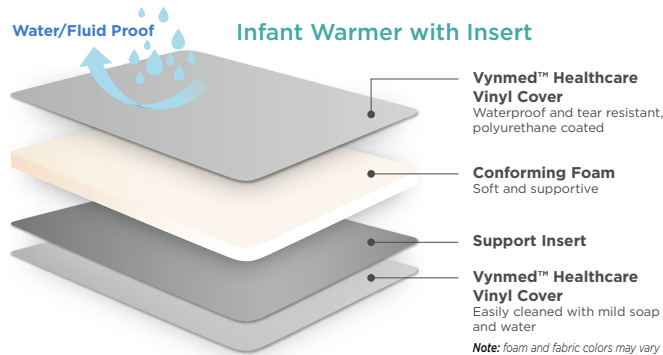
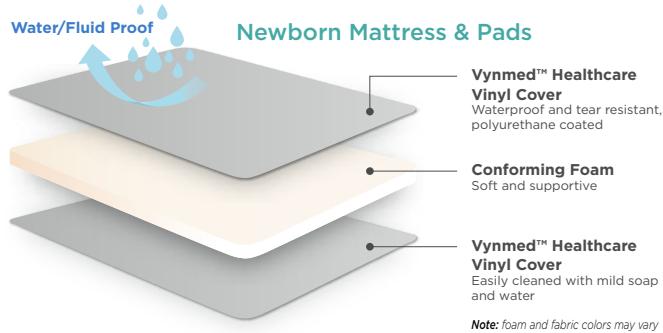

- Sealed Seams
- Support Insert
- Patient Weight Limit Newborn **150**
- Patient Weight Limit Infant Warmers **20**
- Vynmed™ Vinyl Cover
- Waterproof
- Easy to Clean
- Phthalate Free
- CertiPUR-US Foam
- 12 Month Warranty
- Made in the USA



Pediatric Mattresses & Pads

Crib & Youth Mattresses

You can be confident that your little patients are cozy and comfortable on their Marathon Mattresses™ designed for Bassinets, Cribs, Cradles, Infant Care Stations, and Infant Warmers

Sealed Seams

Vynmed™ Healthcare Vinyl Cover

- Durable, soft-supple feel offers exceptional comfort
- Phthalate Free
- Water and stain resistant
- Anti-bacterial, anti-fungal
- Non-allergenic, non-irritating
- Latex free and odor resistant

Crib & Youth Mattress Core

- 3.5" - 6" thick CertiPUR-US foam
- Soft conforming layer
- Supportive foam base layer
- This model does not include plastic support insert

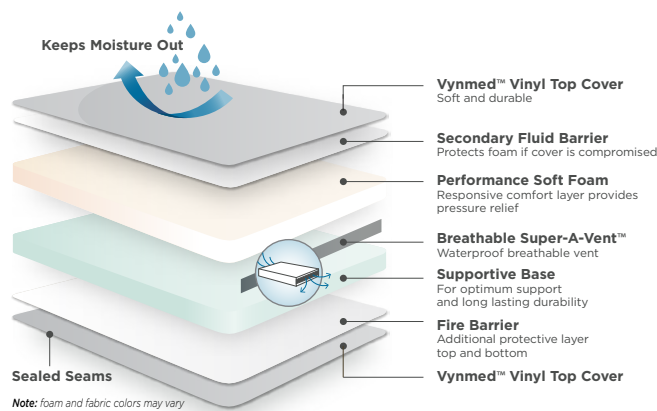

- Sealed Seams
- Support Insert
- Patient Weight Limit
150 Crib & Youth
- Vynmed™ Vinyl Cover
- Waterproof
- Easy to Clean
- Phthalate Free
- CertiPUR-US Foam
- 12 Month Warranty
- Made in the USA

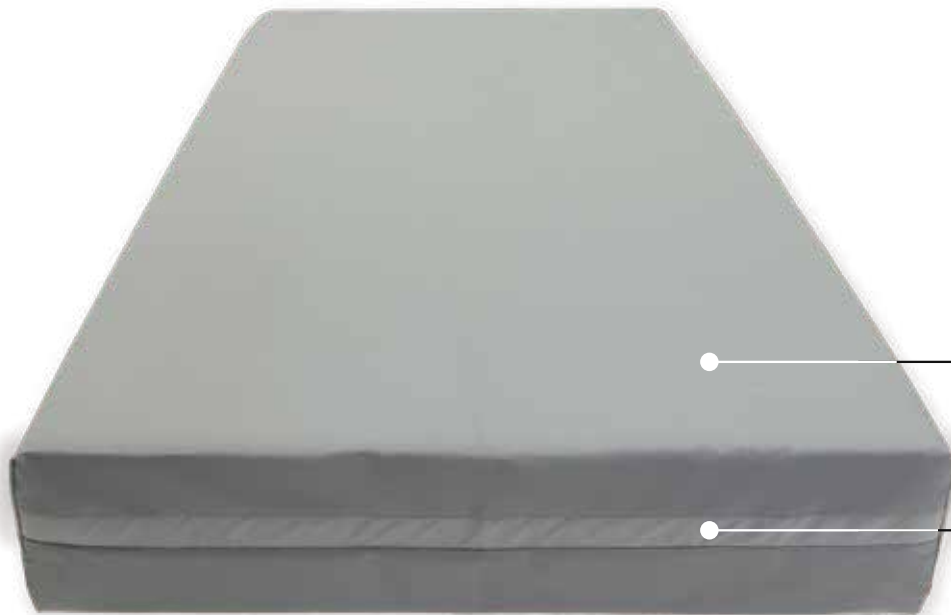

Vynmed™ Waterproof Vinyl Cover

Breathable Super-A-Vent™

Pediatric Mattresses

Newborn Crib

| Size | Order No. |
|--------------------|----------------|
| 24" x 12" x 1.5" | 27-24121.5-S |
| 24" x 13.5" x 1" | 27-2413.51-S |
| 25" x 12" x 1" | 27-25121-S |
| 25" x 12" x 2" | 27-25122-S |
| 25" x 18" x 1" | 27-25181-S |
| 25" x 20" x 1" | 27-25201-S |
| 25" x 22" x 1" | 27-25221-S |
| 25.5" x 12" x 1" | 27-25.5121-S |
| 25.5" x 12" x 1.5" | 27-25.5121.5-S |
| 26" x 12" x 1.5" | 27-26121.5-S |
| 26" x 12" x 2" | 27-26122-S |
| 26" x 12.5" x 1" | 27-2612.51-S |
| 26" x 12.5" x 2" | 27-2612.52-S |
| 26" x 13" x 2" | 27-26132-S |
| 26" x 13.5" x 2" | 27-2613.52-S |
| 27" x 13" x 2" | 27-27132-S |
| 27" x 16" x 2" | 27-27162-S |
| 28" x 16" x 2" | 27-28162-S |
| 33" x 13.5" x 2" | 27-3313.52-S |

Crib & Youth

| Size | Order No. | Size | Order No. |
|--|--------------|--------------------|--------------|
| 44" x 30" x 4" | 39-44304 | 57" x 27" x 4" | 39-57274 |
| 48" x 24" x 4" | 39-48244 | 57" x 32" x 4" | 39-57324 |
| 52" x 27" x 5" | 39-52275 | 58" x 27" x 4" | 39-58274 |
| 52" x 28" x 4" | 39-52284 | 58" x 32" x 6" | 39-58326 |
| 55" x 27" x 5" | 39-55275 | 58" x 32.75" x 4" | 39-5832.754 |
| 55" x 32" x 5" | 39-55325 | 58" x 34" x 4" | 39-58344 |
| 56" x 26" x 3.5" | 39-56263.5 | 58.5" x 33.5" x 5" | 39-58.533.55 |
| 56" x 26" x 3.5" (Pedigo-rounded corners) | 5860002 | 60" x 26" x 4" | 39-60264 |
| 56" x 26" x 5" | 39-56265 | 67" x 31" x 4" | 39-67314 |
| 56" x 27" x 4" | 39-56274 | 68" x 32" x 6" | 39-68326 |
| 56" x 27" x 6" | 39-56276 | 69" x 32" x 4" | 39-69324 |
| 56" x 31" x 4" | 39-56314 | 69" x 33" x 4" | 39-69334 |
| 56.5" x 26.5" x 4" | 39-56.526.54 | 70" x 33" x 5" | 39-70335 |

Many other sizes available
please call for part number

Pediatric Mattress Pads

Infant Pads

| Size | Order No. |
|--------------------------------|------------------|
| 22" x 18" x 1" | 27-22181-S |
| 22" x 18" x 1" (pack of 5) | 27-22181 |
| 23" x 14.5" x 1" | 27-2314.51-S |
| 23.5" x 17.5" x 1" | 27-23.517.51-S |
| 24" x 13" x 1" | 27-24131-S |
| 24" x 13" x 1" (pack of 5) | 27-24131 |
| 24" x 18" x 1" | 27-24181-S |
| 24" x 18" x 1.5" | 27-24181.5-S |
| 24.5" x 13.5" x 2" | 27-24.513.52-S |
| 25" x 13.5" x 2" | 27-2513.52-S |
| 25" x 14" x 1" | 27-25141-S |
| 25" x 17" x 1" | 27-25171-S |
| 25" x 18" x 1" | 27-25181-S |
| 25" x 18" x 1" (pack of 5) | 27-25181 |
| 25" x 18.5" x 1.5" | 27-2518.51.5-S |
| 25.5" x 12" x 1" | 27-25.5121-S |
| 25.5" x 13.5" x 1" | 27-25.513.51-S |
| 25.5" x 13.5" x 1" (pack of 5) | 27-25.513.51 |
| 25.5" x 13.5" x 2" | 27-25.513.52-S |
| 25.5" x 13.5" x 2" (pack of 5) | 27-25.513.52 |
| 26" x 19" x 1" | 27-26191-S |
| 26" x 20" x 1" | 27-26201-S |
| 26" x 20" x 1" (pack of 5) | 27-26201 |
| 26" x 20.5" x 1" | 27-2620.51-S |
| 26" x 22" x 1" | 27-26221-S |
| 27.5" x 14" x 2" | 27-27.5142-S |
| 28" x 17.5" x 1" (Chaparral) | 27-2817.51-S |
| 28.5" x 22.5" x 1" | 27-28.522.51-S |
| 28.5" x 22.5" x 1.5" | 27-28.522.51.5-S |
| 32" x 23.75" x 1" | 27-3223.751-S |
| 36" x 19" x 1" | 27-36191-S |
| 36" x 19" x 1" (pack of 5) | 27-36191 |

Infant Warmer with Support Insert

| Size | Order No. |
|---------------------|---------------|
| 23" x 20" x 1" | 28-23201 |
| 24" x 14" x 1" | 28-24141 |
| 24.5" x 13.5" x 1" | 28-24.513.51 |
| 25" x 18" x 1" | 28-25181 |
| 25" x 20" x 1" | 28-25201 |
| 25.75" x 20.5" x 1" | 28-25.7520.51 |
| 26" x 19" x 1" | 28-26191 |
| 26" x 20" x 1" | 28-26201 |
| 26" x 21" x 1" | 28-26211 |
| 30" x 23" x 1" | 28-30231 |
| 36" x 24" x 1" | 28-36141 |

Part numbers are single pads unless noted as pack of 5